

Nerezové komínové systémy
Oceľové dymovody

2026

ÚVOD

Pravidlá pre používanie nerezového pretlakového komínového systému:

- **pri použití nerezovej komínovej vložky pre pretlakový systém do 200 Pa trieda P1 (tzv. turbo, kondenzačné kotle) je nutné použiť silikónové tesnenie pre každý spoj jednotlivých komponentov;**
- **silikónové tesnenie je súčasťou všetkých prvkov v priemeroch DN 80 a DN 100;**
- **od priemerov DN 110 a vyššie je nutné objednať tesnenie zvlášť;**
- **od priemerov DN 110 a vyššie sa na každý spoj používajú spojovacie objímky;**
- **pre pretlakový systém do 5000 Pa trieda H1 sa používajú spojovacie objímky s vonkajšou silikónovou manžetou;**
- **systém je možné použiť pre teplotu spalín do 200°C.**

Pravidlá pre používanie nerezového podtlakového komínového systému:

- **pri použití komínovej vložky pre podtlakový systém triedy N1;**
- **na každý spoj sa používajú nerezové spojovacie objímky;**
- **systém je certifikovaný pre teplotnú triedu T250 a T600.**

<i>Úvod</i>	<i>2</i>
<i>Obsah a kontakty</i>	<i>3</i>
<i>Zľavové skupiny</i>	<i>4</i>
<i>Charakteristika podľa EN 1856-1 a EN 1856-2</i>	<i>5, 68</i>
<i>Nerezový systém jednoduchý SW - 0,4 mm</i>	<i>6-14</i>
<i>Nerezový systém trojzložkový DW + DWLAK - 0,4 mm</i>	<i>15-30</i>
<i>Nerezový systém trojzložkový DW6 + DW6LAK - 0,6 mm</i>	<i>31-39</i>
<i>Nerezový systém jednoduchý S8V2 - 0,8 mm</i>	<i>40-46</i>
<i>Nerezový systém jednoduchý S10 - 1 mm</i>	<i>47-53</i>
<i>Oválne komínové vložky S8V2 - 0,8 mm a S10 - 1 mm</i>	<i>54-57</i>
<i>Nerezový systém trojzložkový B10 - 1mm/AL</i>	<i>58-61</i>
<i>Komínový systém pre odťah spalín zo spotrebičov na peletky</i>	<i>62-64</i>
<i>Oceľové dymovody - 1,5 mm</i>	<i>65-70</i>
<i>Flexibilný nerezový systém</i>	<i>71-78</i>
<i>Flexi pre sanáciu komínových telies</i>	<i>79</i>
<i>Rozvod vzduchotechniky</i>	<i>80</i>

RICOM gas s.r.o.
Devínska Nová Ves 7468
841 07 Bratislava

IČO: 55030106
DIČ: 2121845077
IČ DPH: SK2121845077
WEB: www.ricomgas.sk

Objednávky:
tel.: +421 948 881 120
e-mail: info@ricomgas.sk



1	<i>AlFlex</i>	<i>Hliníkový flexibilný systém</i>
2	<i>Čierna oceľ</i>	<i>Čierna dymovina</i>
3	<i>Dinak</i>	<i>Nerezové komínové systémy hr. 0,4 mm</i>
4	<i>FlexiSys</i>	<i>Plastové komínové systémy - flexi systém</i>
5	<i>Koncen</i>	<i>Koncentrické odvody spalín PP/LP, AL/AL, P/N</i>
6	<i>Nerez RICOM</i>	<i>Nerezové komínové systémy hr. 0,8 a 1 mm</i>
7	<i>NerezPre</i>	<i>Nerezový flexibilný systém - pretlak</i>
9	<i>NerezPod-0,4</i>	<i>Nerezový flexibilný systém - podtlak - 0,4 mm</i>
13	<i>Stav. prvky</i>	<i>Stavebné prvky - BLK, izolácia, SIGA, ostatné</i>
14	<i>RúrovéAL</i>	<i>Rúrové hliníkové odvody spalín</i>
15	<i>RúrovýSys</i>	<i>Plastové komínové systémy - rúrový systém</i>
16	<i>B10</i>	<i>Nerezový systém trojzložkový B10</i>
17	<i>Prestupy</i>	<i>Prestupy CIKO</i>
18	<i>Reg</i>	<i>Regulátory ťahu Darco</i>
X	<i>Ostatné</i>	<i>Ostatné - zľava individuálna</i>

Charakteristika podľa EN 1856-1 a EN 1856-2

Systémový komín DINAK	EN 1856-1	T200	P1	W	V2	L50040	O(50)
	EN 1856-1	T250	N1	W	V2	L50040	O(50)
	EN 1856-2	T600	N1	W	V2	L50040	G

Komínové vložky S8V2 a S10	EN 1856-1	T600	N1	D	Vm	L50080	G
	EN 1856-2	T600	N1	D	Vm	L500100	G

Komín trojzložkový DINAK DW	EN 1856-1	T200	P1	W	V2	L50040	O(00)
	EN 1856-1	T450	N1	W	V2	L50040	O(40)
	EN 1856-1	T600	N1	W	V2	L50040	G(60)

Trojvrstvový systémový komín B10	EN 1856-1	T400	N1	D	Vm	L500100	G(100)
-------------------------------------	-----------	------	----	---	----	---------	--------

Komín trojzložkový DINAK DW6	EN 1856-1	T600	N1	D	V3	L50060	G(60)
---------------------------------	-----------	------	----	---	----	--------	-------

Oceľové dymovody	EN 1856-1	T400	N1	D	Vm	L01150	G200
------------------	-----------	------	----	---	----	--------	------

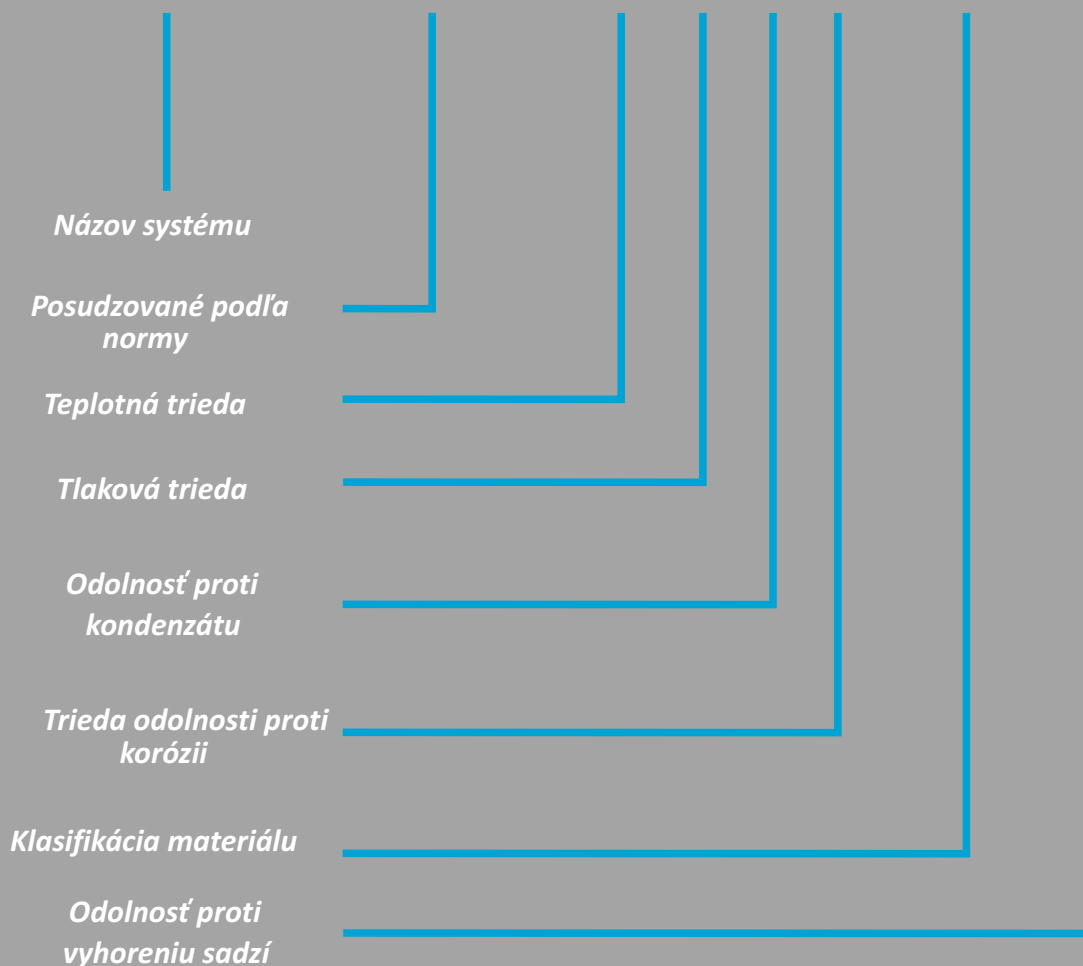

S tesnením - kondenzačný kotol

Bez tesnenia - pevné palivá, suchá prevádzka

EN 1856-1 T200 P1 W V2 L50040 O(50)

EN 1856-1 T250 N1 W V2 L50040 O(50)

EN 1856-2 T600 N1 W V2 L50040 G

Nerezový systém jednoduchý SW		strana
A	komínová hlavica	13
B	predĺženie 265 mm	7
C	predĺženie 930 mm	7
D	čistiaci a revízny kus	12
E	predĺženie 265 mm	7
F	t - kus 90°	11
G	uzáver s odtokom kondenzátu	11

Uľahčíte si prácu so zostavením a kalkuláciou komínového systému:

www.ricomgas.sk

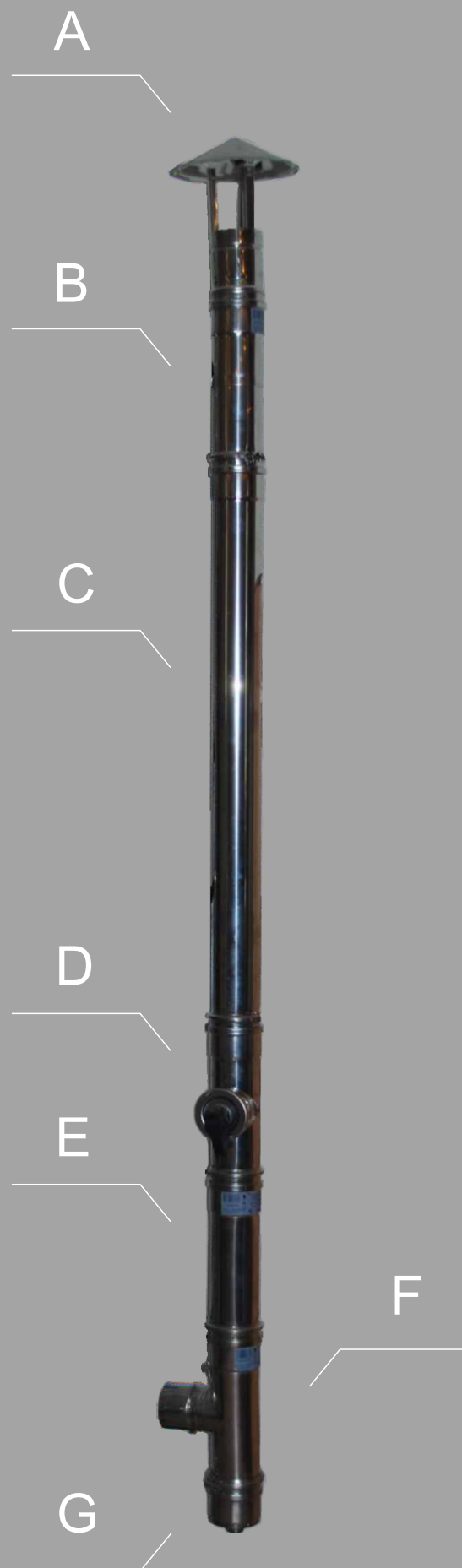

Ceny priemerov väčších ako DN 300 na vyžiadanie u obchodného zástupcu.

Rúra - 265 mm

3

DN	Kód produktu	Cena	€ - SK
60	06025SWJ	450	18,8
80	08025SWJ	273	11,4
100	10025SWJ	318	13,3
110	11025SW	278	11,6
120	1A025SW	321	13,4
125	12025SW	325	13,5
130	13025SW	340	14,2
140	14025SW	369	15,4
150	15025SW	391	16,3
160	16025SW	429	17,9
180	18025SW	468	19,5
200	20025SW	518	21,6
250	25025SW	671	28,0
300	30025SW	916	38,2



Rúra nastaviteľná 65 - 206 mm

3

DN	Kód produktu	Cena	€ - SK
80	08023SWJ	454	18,9
100	10023SWJ	510	21,3
110	11023SW	523	21,8
120	1A023SW	542	22,6
130	13023SW	643	26,8
140	14023SW	608	25,3
150	15023SW	694	28,9
160	16023SW	785	32,7
180	18023SW	832	34,7
200	20023SW	903	37,6
250	25023SW	1 117	46,5
300	30023SW	1 384	57,7



Rúra - 430 mm

3

DN	Kód produktu	Cena	€ - SK
60	06024SWJ	605	25,2
80	08024SWJ	359	15,0
100	10024SWJ	417	17,4
110	11024SW	388	16,2
120	1A024SW	419	17,5
125	12024SW	447	18,6
130	13024SW	468	19,5
140	14024SW	530	22,1
150	15024SW	537	22,4
160	16024SW	590	24,6
180	18024SW	643	26,8
200	20024SW	713	29,7
250	25024SW	923	38,5
300	30024SW	1 144	47,7



Rúra nastaviteľná 65 - 373 mm

3

DN	Kód produktu	Cena	€ - SK
80	08022SWJ	540	22,5
100	10022SWJ	609	25,4
110	11022SW	621	25,9
120	1A022SW	648	27,0
130	13022SW	771	32,1
140	14022SW	732	30,5
150	15022SW	840	35,0
160	16022SW	945	39,4
180	18022SW	1 006	41,9
200	20022SW	1 098	45,8
250	25022SW	1 369	57,0
300	30022SW	1 612	67,2



Rúra - 930 mm

3

DN	Kód produktu	Cena	€ - SK
60	06020SWJ	755	31,5
80	08020SWJ	585	24,4
100	10020SWJ	676	28,2
110	11020SW	641	26,7
120	1A020SW	728	30,3
125	12020SW	768	32,0
130	13020SW	802	33,4
140	14020SW	778	32,4
150	15020SW	923	38,5
160	16020SW	1 013	42,2
180	18020SW	1 103	46,0
200	20020SW	1 223	51,0
250	25020SW	1 584	66,0
300	30020SW	1 965	81,9



Tesnenie

3

DN	Kód produktu	Cena	€ - SK
60	06001SW	40	1,7
80	08001SW	43	1,8
100	10001SW	54	2,3
110	11001SW	119	5,0
120	1A001SW	136	5,7
125	12001SW	131	5,5
130	13001SW	128	5,3
140	14001SW	121	5,0
150	15001SW	128	5,3
160	16001SW	175	7,3
180	18001SW	171	7,1
200	20001SW	192	8,0
250	25001SW	235	9,8
300	30001SW	257	10,7



Priemer DN 80 a DN 100 obsahuje vnútorné silikónové tesnenie. Pre priemer DN 110 a väčší v prípade pretlakovej inštalácie je nutné doobjednať tesnenie zvlášť. Skladová dostupnosť priemerov DN 250 a väčších je na dotaz.

Kotviaca objímka hladká

3

DN	Kód produktu	Cena	€ - SK
80	08086SW	189	7,9
100	10086SW	193	8,0
110	11086SW	180	7,5
120	1A086SW	192	8,0
125	12086SW	207	8,6
130	13086SW	212	8,8
140	14086SW	218	9,1
150	15086SW	221	9,2
160	16086SW	292	12,2
180	18086SW	365	15,2
200	20086SW	381	15,9
250	25086SW	397	16,5
300	30086SW	474	19,8



Kotviaca objímka hladká 250 - 430 mm

3

DN	Kód produktu	Cena	€ - SK
80	08846SW	1 081	45,0
100	10846SW	1 108	46,2
125	12846SW	1 189	49,5
130	13846SW	1 215	50,6
150	15846SW	1 265	52,7
160	16846SW	1 678	69,9
180	18846SW	2 092	87,2
200	20846SW	2 188	91,2
250	25846SW	2 282	95,1



Predĺženie konzoly 835, 836, 845, 846

3

DN	Kód produktu	Cena	€ - SK
UNI	PK390W	1 164	48,5

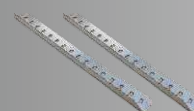

Spojovacia objímka

3

DN	Kód produktu	Cena	€ - SK
60	06070SW	150	6,3
80	08070SW	92	3,8
100	10070SW	92	3,8
110	11070SW	107	4,5
120	1A070SW	109	4,5
125	12070SW	109	4,5
130	13070SW	115	4,8
140	14070SW	105	4,4
150	15070SW	115	4,8
160	16070SW	121	5,0
180	18070SW	127	5,3
200	20070SW	127	5,3
250	25070SW	138	5,8
300	30070SW	138	5,8

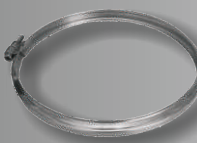

Zakladací diel s odtokom

3

DN	Kód produktu	Cena	€ - SK
110	11065SW	1 953	81,4
120	1A065SW	1 999	83,3
130	13065SW	2 298	95,8
140	14065SW	2 160	90,0
150	15065SW	2 452	102,2
160	16065SW	2 503	104,3
180	18065SW	2 554	106,4
200	20065SW	2 691	112,1
250	25065SW	2 828	117,8
300	30065SW	3 677	153,2



Kotviaca objímka hladká 100 - 250 mm

3

DN	Kód produktu	Cena	€ - SK
80	08836SW	865	36,0
100	10836SW	886	36,9
110	11836SW	826	34,4
120	1A836SW	624	26,0
125	12836SW	951	39,6
130	13836SW	972	40,5
140	14836SW	902	37,6
150	15836SW	1 012	42,2
160	16836SW	1 343	56,0
180	18836SW	1 673	69,7
200	20836SW	1 751	73,0
250	25836SW	1 825	76,0
300	30836SW	2 178	90,8

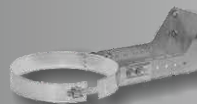

Konzola

3

DN	Kód produktu	Cena	€ - SK
80	08857SW	872	36,3
100	10857SW	1 016	42,3
110	11857SW	1 007	42,0
120	1A857SW	1 031	43,0
130	13857SW	1 167	48,6
140	14857SW	1 259	52,5
150	15857SW	1 444	60,2
160	16857SW	1 461	60,9
180	18857SW	1 533	63,9
200	20857SW	1 978	82,4
250	25857SW	2 347	97,8
300	30857SW	2 534	105,6

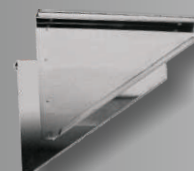

Priemer DN 80 a DN 100 obsahuje vnútorné silikónové tesnenie.
Pre priemer DN 110 a väčší v prípade pretlakovej inštalácie
je nutné doobjednať tesnenie zvlášť.
Skladová dostupnosť priemerov DN 250 a väčších je na dotaz.

Podporný diel

3

DN	Kód produktu	Cena	€ - SK
125	12854SW	2 148	89,5
130	13854SW	2 196	91,5
140	14854SW	2 041	85,0
150	15854SW	2 294	95,6
160	16854SW	2 344	97,7
180	18854SW	2 394	99,8
200	20854SW	2 502	104,3
250	25854SW	2 850	118,8
300	30854SW	6 146	256,1

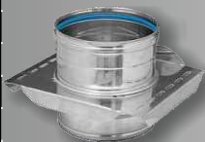

Vystredovacia objímka dvojité

15

DN	Kód produktu	Cena	€ - SK
80	37080/2	291	12,1
100	37100/2	310	12,9
110	37110/2	334	13,9
125	37125/2	370	15,4
130	37130/2	424	17,7
140	37140/2	443	18,5
150	37150/2	455	19,0
160	37160/2	475	19,8
180	37180/2	497	20,7
200	37250/2	557	23,2
250	37200/2	545	22,7
300	37300/2	709	29,5

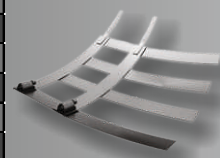

Zakladacia konzola pre T-kus

15

DN	Kód produktu	Cena	€ - SK
80	48080	830	34,6
110	48110	1 223	51,0
125	48125	1 430	59,6
130	48130	1 096	45,7
140	48140	1 132	47,2
150	48150	1 181	49,2
160	48160	1 598	66,6
180	48180	1 259	52,5
200	48200	1 641	68,4
250	48250	1 762	73,4
300	48300	2 064	86,0

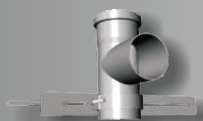
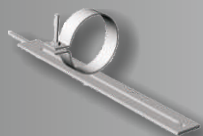

Koleno 15°

3

DN	Kód produktu	Cena	€ - SK
80	08044SWJ	418	17,4
100	10044SWJ	487	20,3
110	11044SW	506	21,1
120	1A044SW	441	18,4
125	12044SW	495	20,6
130	13044SW	505	21,0
140	14044SW	486	20,3
150	15044SW	565	23,5
160	16044SW	635	26,5
180	18044SW	705	29,4
200	20044SW	798	33,3
250	25044SW	1 006	41,9
300	30044SW	1 716	71,5



Zakladacia konzola pre koleno

15

DN	Kód produktu	Cena	€ - SK
80	46080	830	34,6
*110	46110	1 223	51,0
125	46125	1 430	59,6
130	46130	1 096	45,7
140	46140	1 132	47,2
150	46150	1 181	49,2
160	46160	1 598	66,6
180	46180	1 259	52,5
200	46200	1 641	68,4
250	46250	1 762	73,4
300	46300	2 064	86,0

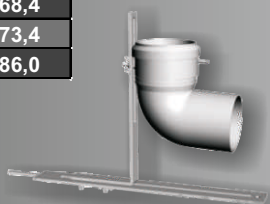

Koleno 30°

3

DN	Kód produktu	Cena	€ - SK
80	08042SWJ	418	17,4
100	10042SWJ	487	20,3
110	11042SW	506	21,1
120	1A042SW	441	18,4
125	12042SW	495	20,6
130	13042SW	505	21,0
140	14042SW	486	20,3
150	15042SW	565	23,5
160	16042SW	635	26,5
180	18042SW	705	29,4
200	20042SW	798	33,3
250	25042SW	1 006	41,9
300	30042SW	1 716	71,5



* - DN 110 je možné použiť na DN 100

Priemer DN 80 a DN 100 obsahuje vnútorné silikónové tesnenie. Pre priemer DN 110 a väčší v prípade pretlakovej inštalácie je nutné doobjednať tesnenie zvlášť. Skladová dostupnosť priemerov DN 250 a väčších je na dotaz.

Koleno 45°

3

DN	Kód produktu	Cena	€ - SK
60	06040SWJ	590	24,6
80	08040SWJ	384	16,0
100	10040SWJ	448	18,7
110	11040SW	424	17,7
120	1A040SW	421	17,5
125	12040SW	450	18,8
130	13040SW	459	19,1
140	14040SW	532	22,2
150	15040SW	514	21,4
160	16040SW	578	24,1
180	18040SW	641	26,7
200	20040SW	726	30,3
250	25040SW	914	38,1
300	30040SW	1 560	65,0



Koleno revízne 87°

3

DN	Kód produktu	Cena	€ - SK
80	08431SWJ	649	27,0
100	10431SWJ	738	30,8
110	11431SW	738	30,8
120	1A431SW	789	32,9
125	12431SW	801	33,4
130	13431SW	820	34,2
140	14431SW	792	33,0
150	15431SW	921	38,4
160	16431SW	1 047	43,6
180	18431SW	1 172	48,8
200	20431SW	1 296	54,0
250	25431SW	1 630	67,9
300	30431SW	2 062	85,9



Koleno 87°

3

DN	Kód produktu	Cena	€ - SK
80	08043SWJ	548	22,8
100	10043SWJ	624	26,0
110	11043SW	561	23,4
120	1A043SW	627	26,1
125	12043SW	667	27,8
130	13043SW	684	28,5
140	14043SW	733	30,5
150	15043SW	768	32,0
160	16043SW	872	36,3
180	18043SW	977	40,7
200	20043SW	1 080	45,0
250	25043SW	1 358	56,6
300	30043SW	1 719	71,6

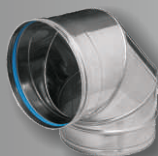

Koleno revízne 90°

3

DN	Kód produktu	Cena	€ - SK
80	08432SWJ	649	27,0
100	10432SWJ	738	30,8
110	11432SW	762	31,8
120	1A432SW	716	29,8
125	12432SW	801	33,4
130	13432SW	820	34,2
140	14432SW	922	38,4
150	15432SW	921	38,4
160	16432SW	1 047	43,6
180	18432SW	1 172	48,8
200	20432SW	1 296	54,0
250	25432SW	1 630	67,9
300	30432SW	2 062	85,9

3

Koleno 90°

3

DN	Kód produktu	Cena	€ - SK
60	06433SWJ	730	30,4
80	08433SWJ	548	22,8
100	10433SWJ	624	26,0
110	11433SW	556	23,2
120	1A433SW	673	28,0
125	12433SW	667	27,8
130	13433SW	684	28,5
140	14433SW	726	30,3
150	15433SW	768	32,0
160	16433SW	872	36,3
180	18433SW	977	40,7
200	20433SW	1 080	45,0
250	25433SW	1 358	56,6
300	30433SW	1 719	71,6

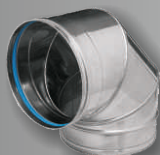

T - kus 93°

3

DN	Kód produktu	Cena	€ - SK
80	0831ASWJ	726	30,3
100	1031ASWJ	834	34,8
110	1131ASW	881	36,7
120	1A31ASW	976	40,7
130	1331ASW	1 112	46,3
140	1431ASW	1 195	49,8
150	1531ASW	1 267	52,8
160	1631ASW	1 365	56,9
180	1831ASW	1 463	61,0
200	2031ASW	1 755	73,1
250	2531ASW	2 145	89,4
300	3031ASW	2 534	105,6



Priemer DN 80 a DN 100 obsahuje vnútorné silikónové tesnenie. Pre priemer DN 110 a väčší v prípade pretlakovej inštalácie je nutné doobjednať tesnenie zvlášť. Skladová dostupnosť priemerov DN 250 a väčších je na dotaz.

T - kus redukovaný 93°

③

DN	Kód produktu	Cena	€ - SK
110/80	KI31BSW	1 375	57,3
120/80	BA31BSW	1 463	61,0
150/80	DE31BSW	1 901	79,2
160/80	VB31BSW	2 047	85,3
130/100	CH31BSW	1 667	69,5
140/100	XN31BSW	1 784	74,3
150/100	DF31BSW	1 901	79,2
180/100	DU31BSW	2 193	91,4
200/100	ES31BSW	2 632	109,7
200/125	2031BSW	2 632	109,7



T - kus 90°

③

DN	Kód produktu	Cena	€ - SK
60	06031SWJ	923	38,5
80	08031SWJ	726	30,3
100	10031SWJ	834	34,8
110	11031SW	960	40,0
120	1A031SW	988	41,2
125	12031SW	1 043	43,5
130	13031SW	1 112	46,3
140	14031SW	1 231	51,3
150	15031SW	1 267	52,8
160	16031SW	1 365	56,9
180	18031SW	1 463	61,0
200	20031SW	1 755	73,1
250	25031SW	2 145	89,4
300	30031SW	2 534	105,6



T - kus 135° pre suchú prevádzku

③

DN	Kód produktu	Cena	€ - SK
130	13030SW	1 945	81,0
150	15030SW	2 218	92,4
160	16030SW	2 388	99,5
180	18030SW	2 559	106,6
200	20030SW	3 071	128,0
250	25030SW	3 753	156,4
300	30030SW	4 435	184,8



Uzáver

③

DN	Kód produktu	Cena	€ - SK
80	08060SWJ	292	12,2
100	10060SWJ	360	15,0
110	11060SW	335	14,0
120	1A060SW	354	14,8
125	12060SW	342	14,3
130	13060SW	345	14,4
140	14060SW	379	15,8
150	15060SW	388	16,2
160	16060SW	422	17,6
180	18060SW	455	19,0
200	20060SW	506	21,1
250	25060SW	621	25,9
300	30060SW	837	34,9

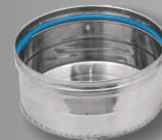

Uzáver s odtokom kondenzátu

③

DN	Kód produktu	Cena	€ - SK
80	08061SWJ	466	19,4
100	10061SWJ	509	21,2
110	11061SW	518	21,6
120	1A061SW	508	21,2
125	12061SW	504	21,0
130	13061SW	517	21,5
140	14061SW	594	24,8
150	15061SW	550	22,9
160	16061SW	592	24,7
180	18061SW	635	26,5
200	20061SW	673	28,0
250	25061SW	784	32,7
300	30061SW	963	40,1



Uzáver s bočným odtokom

③

DN	Kód produktu	Cena	€ - SK
130	13613SW	613	25,5
140	14613SW	726	30,3
150	15613SW	768	32,0
160	16613SW	740	30,8
180	18613SW	793	33,0
200	20613SW	963	40,1
250	25613SW	1 068	44,5
300	30613SW	1 204	50,2



Priemer DN 80 a DN 100 obsahuje vnútorné silikónové tesnenie. Pre priemer DN 110 a väčší v prípade pretlakovej inštalácie je nutné doobjednať tesnenie zvlášť. Skladová dostupnosť priemerov DN 250 a väčších je na dotaz.

Záslepka odtoku kondenzátu s tesnením ③

DN	Kód produktu	Cena	€ - SK
3/4"	NA61	62	2,6
3/4"	NA61-316	90	3,8

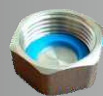

- NA61 mosadzné viečko M 3/4", vr. tesnenia
- NA61-616 nerezové viečko M 3/4", vr. tesnenia

Čistiaci a revízny kus ③

DN	Kód produktu	Cena	€ - SK
80	08528SWJ	1 302	54,3
100	10528SWJ	1 537	64,0
110	11528SW	1 544	64,3
120	1A528SW	1 774	73,9
130	13528SW	1 931	80,5
140	14528SW	2 102	87,6
150	15528SW	2 191	91,3
160	16528SW	2 368	98,7
180	18528SW	2 544	106,0
200	20528SW	2 973	123,9
250	25528SW	3 408	142,0
300	30528SW	3 844	160,2



Čistiaci a revízny kus ③

DN	Kód produktu	Cena	€ - SK
110	11521SW	2 944	122,7
120	1A521SW	3 025	126,0
130	13521SW	3 333	138,9
140	14521SW	3 244	135,2
150	15521SW	3 801	158,4
160	16521SW	4 094	170,6
180	18521SW	4 240	176,7
200	20521SW	4 386	182,8
250	25521SW	4 825	201,0
300	30521SW	5 702	237,6



Kontrolný kus ③

DN	Kód produktu	Cena	€ - SK
80	08050SWJ	689	28,7
100	10050SWJ	741	30,9
110	11050SW	653	27,2
120	1A050SW	676	28,2
130	13050SW	780	32,5
140	14050SW	738	30,8
150	15050SW	842	35,1
160	16050SW	889	37,0
180	18050SW	936	39,0
200	20050SW	998	41,6
250	25050SW	1 185	49,4
300	30050SW	1 483	61,8



Priemer DN 80 a DN 100 obsahuje vnútorné silikónové tesnenie. Pre priemer DN 110 a väčší v prípade pretlakovej inštalácie je nutné doobjednať tesnenie zvlášť. Skladová dostupnosť priemerov DN 250 a väčších je na dotaz.

Kryt komína s prechodom SW/DW - dilatačný ③

DN	Kód produktu	Cena	€ - SK
130	1367SDW	1 840	76,7
150	1567SDW	2 240	93,3
160	1667SDW	2 302	95,9
180	1867SDW	2 480	103,3
200	2067SDW	3 000	125,0

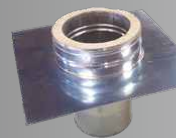

Redukcia ③

DN	Kód produktu	Cena	€ - SK
100/80	Y0026SWJ	1 039	43,3
110/100	KH026SW	983	41,0
120/110	KL026SW	1 085	45,2
150/120	BF026SW	1 256	52,3



Adaptér ③

DN	Kód produktu	Cena	€ - SK
80/100	AD026SWJ	886	36,9
80/110	KI026SW	996	41,5
80/120	BA026SW	1 028	42,8
80/130	CG026SW	1 135	47,3
80/180	DT026SW	1 502	62,6
100/110	KJ026SW	1 074	44,8
100/125	BZ026SW	1 237	51,5
100/130	CH026SW	1 010	42,1
100/140	XN026SW	832	34,7
100/150	DF026SW	1 356	56,5
100/160	ZA026SW	1 447	60,3
100/180	DU026SW	1 502	62,6
100/200	ES026SW	1 666	69,4
110/120	LG026SW	1 129	47,0
110/130	LI026SW	1 130	47,1
110/140	XO026SW	1 175	49,0
110/150	LJ026SW	1 256	52,3
110/160	ZB026SW	1 380	57,5
110/180	LM026SW	1 502	62,6
110/200	LN026SW	1 666	69,4
120/130	CI026SW	1 109	46,2
120/180	DV026SW	1 502	62,6
125/130	CJ026SW	1 125	46,9
125/140	LP026SW	1 175	49,0
130/140	XQ026SW	1 174	48,9
130/150	DH026SW	1 365	56,9
130/160	YC026SW	1 432	59,7
130/180	DX026SW	1 009	42,0
140/150	YI026SW	1 268	52,8
150/160	ZD026SW	1 358	56,6
150/180	DY026SW	1 554	64,8
150/200	M4026SW	1 666	69,4
150/250	M7026SW	2 232	93,0
160/180	XC026SW	1 417	59,0
160/200	XD026SW	1 666	69,4
160/250	XE026SW	1 964	81,8
180/200	EV026SW	1 666	69,4
180/250	GY026SW	2 157	89,9
200/250	M9026SW	1 968	82,0



Komínová hlavica - orol

③

DN	Kód produktu	Cena	€ - SK
130	13010ORL	2 825	117,7
150	15010ORL	3 458	144,1
160	16010ORL	3 960	165,0
180	18010ORL	3 990	166,3
200	20010ORL	4 632	193,0
250	25010ORL	5 023	209,3



Komínová hlavica

③

DN	Kód produktu	M	Cena	€ - SK
60	06010SWP	125	512	21,3
80	08010SWP	180	569	23,7
80	08010SW	180	903	37,6
100	10010SW	230	969	40,4
110	11010SW	250	1 056	44,0
120	1A010SW	270	964	40,2
125	12510SWP	270	819	34,1
130	13010SW	290	1 136	47,3
140	14010SW	300	1 284	53,5
150	15010SW	320	1 277	53,2
160	16010SW	350	1 386	57,8
180	18010SW	390	1 494	62,3
200	20010SW	410	1 744	72,7
250	25010SW	490	2 203	91,8
300	30010SW	590	2 892	120,5



08010SWP

Golier vysoký

③

DN	Kód produktu	Cena	€ - SK
80	08V13SW	475	19,8
100	10V13SW	513	21,4
110	11V13SW	539	22,5
120	1AV13SW	571	23,8
130	13V13SW	621	25,9
140	14V13SW	609	25,4
150	15V13SW	647	27,0
160	16V13SW	635	26,5
180	18V13SW	628	26,2
200	20V13SW	718	29,9
250	25V13SW	910	37,9
300	30V13SW	1 025	42,7



Ukončenie komína

③

DN	Kód produktu	Cena	€ - SK
80	08011SW	675	28,1
100	10011SW	711	29,6
110	11011SW	680	28,3
120	1A011SW	721	30,0
130	13011SW	824	34,3
140	14011SW	948	39,5
150	15011SW	909	37,9
160	16011SW	986	41,1
180	18011SW	1 062	44,3
200	20011SW	1 157	48,2
250	25011SW	1 447	60,3
300	30011SW	1 801	75,0



Golier plochý

③

DN	Kód produktu	Cena	€ - SK
60	06013SW	568	23,7
80	08013SW	473	19,7
100	10013SW	630	26,3
110	11013SW	663	27,6
120	1A013SW	701	29,2
125	12013SW	663	27,6
130	13013SW	764	31,8
140	14013SW	777	32,4
150	15013SW	795	33,1
160	16013SW	799	33,3
180	18013SW	802	33,4
200	20013SW	883	36,8
250	25013SW	1 120	46,7
300	30013SW	1 260	52,5



Hlavica vodorovná

③

DN	Kód produktu	Cena	€ - SK
80	08015SW	903	37,6
100	10015SW	911	38,0
110	11015SW	945	39,4
120	1A015SW	672	28,0
125	12015SW	672	28,0
130	13015SW	1 040	43,3
140	14015SW	1 086	45,3
150	15015SW	1 162	48,4
160	16015SW	1 169	48,7
200	20015SW	1 364	56,8
250	25015SW	2 018	84,1
300	30015SW	2 230	92,9

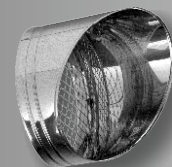

Golier s podperou

③

DN	Kód produktu	Cena	€ - SK
80	0813PSW	479	20,0

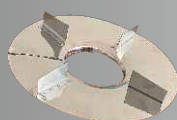

Priemer DN 80 a DN 100 obsahuje vnútorné silikónové tesnenie. Pre priemer DN 110 a väčší v prípade pretlakovej inštalácie je nutné doobjednať tesnenie zvlášť. Skladová dostupnosť priemerov DN 250 a väčších je na dotaz.

Ukončovací kryt komína ③

DN	Kód produktu	Cena	€ - SK
80	08852SW	952	39,7
100	10852SW	1 031	43,0
110	11852SW	1 005	41,9
120	1A852SW	1 233	51,4
130	13852SW	1 209	50,4
140	14852SW	1 230	51,3
150	15852SW	1 296	54,0
160	16852SW	1 379	57,5
180	18852SW	1 462	60,9
200	20852SW	1 672	69,7
250	25852SW	2 236	93,2
300	30852SW	2 655	110,6

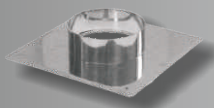

+



Priechodka strechou rovná ③

DN	Kód produktu	Cena	€ - SK
80	08019SW	2 203	91,8
100	10019SW	2 288	95,3
110	11019SW	2 157	89,9
120	1A019SW	2 234	93,1
130	13019SW	2 581	107,5
140	14019SW	2 360	98,3
150	15019SW	2 610	108,8
160	16019SW	2 623	109,3
180	18019SW	2 636	109,8
200	20019SW	2 636	109,8
250	25019SW	3 760	156,7
300	30019SW	3 760	156,7

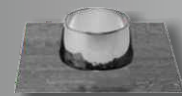

+



Priechodka strechou 30° / 45° ③

DN	Kód produktu	Cena	€ - SK
80	08017SW	2 647	110,3
100	10017SW	2 748	114,5
110	11017SW	2 591	108,0
120	1A017SW	2 967	123,6
125	12017SW	3 102	129,3
130	13017SW	3 102	129,3
140	14017SW	2 832	118,0
150	15017SW	3 129	130,4
160	16017SW	3 143	131,0
180	18017SW	3 157	131,5
200	20017SW	3 157	131,5
250	25017SW	4 285	178,5
300	30017SW	4 285	178,5

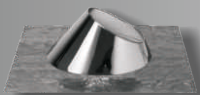

+



Tesnenie pod golier pri priechodke strechou ③

DN	Kód produktu	Cena	€ - SK
80	08J02SW	80	3,3
100	10J02SW	99	4,1
130	13J02SW	180	7,5
150	15J02SW	180	7,5
180	18J02SW	180	7,5
200	20J02SW	200	8,3
230	23J02SW	210	8,8
250	25J02SW	305	12,7
300	30J02SW	309	12,9
350	35J02SW	460	19,2



Priechodka strechou 5° / 30° ③

DN	Kód produktu	Cena	€ - SK
80	08018SW	2 647	110,3
100	10018SW	2 748	114,5
110	11018SW	2 591	108,0
120	1A018SW	2 684	111,8
125	12018SW	3 102	129,3
130	13018SW	3 102	129,3
140	14018SW	2 832	118,0
150	15018SW	3 129	130,4
160	16018SW	3 143	131,0
180	18018SW	3 157	131,5
200	20018SW	3 157	131,5
250	25018SW	4 285	178,5
300	30018SW	4 285	178,5

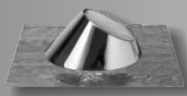

+



Priemer DN 80 a DN 100 obsahuje vnútorné silikónové tesnenie. Pre priemer DN 110 a väčší v prípade pretlakovej inštalácie je nutné doobjednať tesnenie zvlášť. Skladová dostupnosť priemerov DN 250 a väčších je na dotaz.

S tesnením - kondenzačný kotol

Bez tesnenia - pevné palivá, suchá prevádzka

EN 1856-1 T200 P1 W V2 L50040 O(00)

EN 1856-1 T450 N1 W V2 L50040 O(40)

EN 1856-1 T600 N1 W V2 L50040 G(60)

Nerezový systém trojzložkový DW		strana
A	ukončenie komína	21
B	predĺženie 440 mm	16
C	predĺženie 270 mm	16
D	t - kus 90°	19
E	čistiaci a revízny kus s dvierkami - podtlakový	20
F	zakladací diel odtokom kondenzátu	18
G	konzola	18

Uľahčíte si prácu so zostavením a kalkuláciou komínového systému:

www.ricomgas.sk

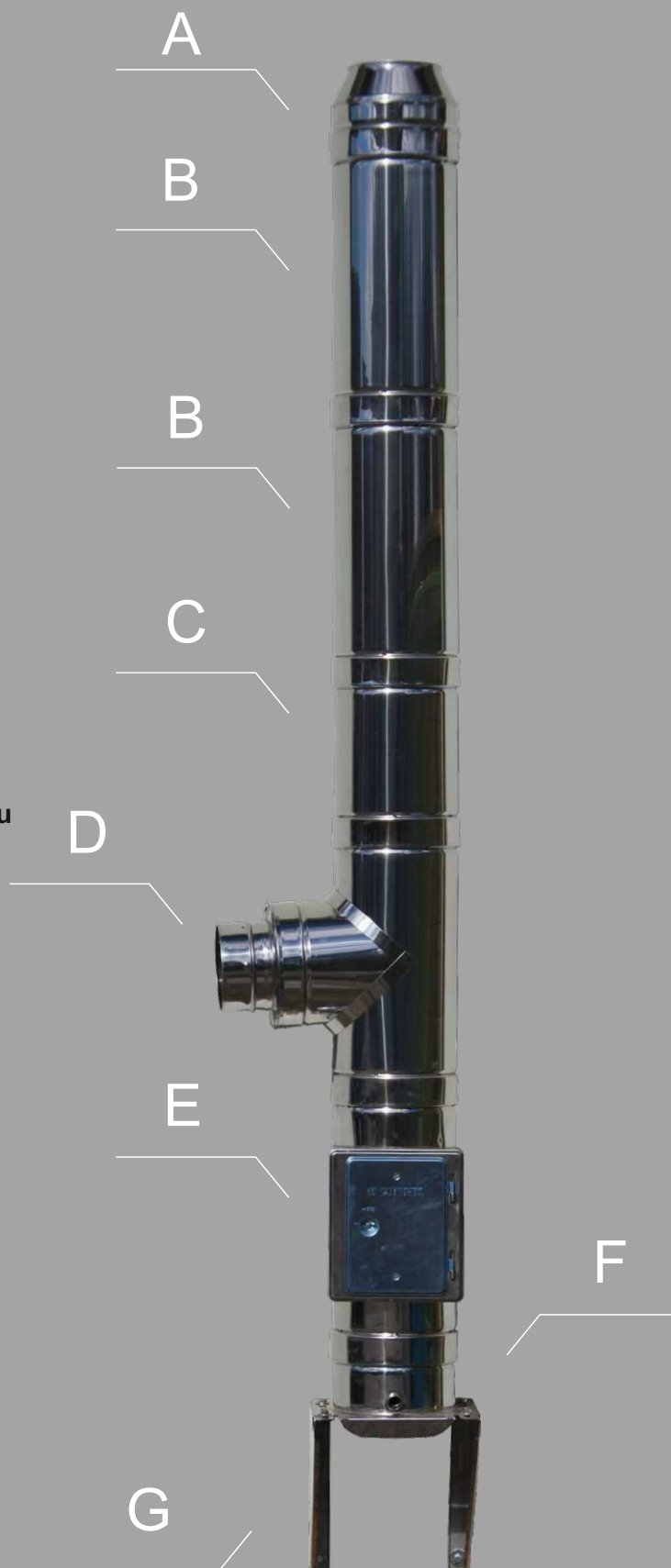

Ceny priemerov väčších ako DN 300 na vyžiadanie u obchodného zástupcu.

Rúra - 140 mm

3

DN	Kód produktu	Cena	€ - SK
80	08255DWJ	728	30,3
100	10255DWJ	804	33,5
130	13255DW	950	39,6
150	15255DW	1 059	44,1
160	16255DW	1 132	47,2
180	18255DW	1 222	50,9
200	20255DW	1 444	60,2
250	25255DW	1 769	73,7



Rúra - 270 mm

3

DN	Kód produktu	Cena	€ - SK
80	08025DWJ	851	35,5
100	10025DWJ	948	39,5
130	13025DW	1 056	44,0
150	15025DW	1 176	49,0
160	16025DW	1 257	52,4
180	18025DW	1 357	56,5
200	20025DW	1 604	66,8
250	25025DW	1 965	81,9
300	30025DW	2 298	95,8



Rúra - 440 mm

3

DN	Kód produktu	Cena	€ - SK
80	08024DWJ	1 012	42,2
100	10024DWJ	1 126	46,9
130	13024DW	1 266	52,8
150	15024DW	1 418	59,1
160	16024DW	1 501	62,5
180	18024DW	1 604	66,8
200	20024DW	1 935	80,6
250	25024DW	2 328	97,0
300	30024DW	2 931	122,1



Rúra - 940 mm

3

DN	Kód produktu	Cena	€ - SK
80	08020DWJ	1 672	69,7
100	10020DWJ	1 816	75,7
130	13020DW	2 056	85,7
150	15020DW	2 298	95,8
160	16020DW	2 419	100,8
180	18020DW	2 568	107,0
200	20020DW	3 140	130,8
250	25020DW	4 015	167,3
300	30020DW	4 804	200,2



Rúra nastaviteľná 530 - 880 mm

3

DN	Kód produktu	Cena	€ - SK
80	08022DWJ	2 075	86,5
100	10022DWJ	2 307	96,1
130	13022DW	2 598	108,3
150	15022DW	2 900	120,8
160	16022DW	3 035	126,5
180	18022DW	3 201	133,4
200	20022DW	3 834	159,8
250	25022DW	4 804	200,2
300	30022DW	5 527	230,3



- nie je určené pre horizontálnu inštaláciu pri aplikáciách s mokrou prevádzkou

Rúra nastaviteľná 350 - 530 mm

3

DN	Kód produktu	Cena	€ - SK
80	08023DWJ	1 613	67,2
100	10023DWJ	1 798	74,9
130	13023DW	1 996	83,2
150	15023DW	2 207	92,0
160	16023DW	2 329	97,0
180	18023DW	2 478	103,3
200	20023DW	2 931	122,1
250	25023DW	3 562	148,4
300	30023DW	4 196	174,8



- nie je určené pre horizontálnu inštaláciu pri aplikáciách s mokrou prevádzkou

Prechodový diel 400 mm

3

DN	Kód produktu	Cena	€ - SK
130	13143DW	1 276	53,2
150	15143DW	1 366	56,9
160	16143DW	1 730	72,1
180	18143DW	1 545	64,4
200	20143DW	1 864	77,7



- prispôsobené pre zasunutie čiernej ocele bez zúženia
- zúženie je nutné odstrániť alebo použiť prechod 11XXSWOC

Prechodový diel 900 mm

3

DN	Kód produktu	Cena	€ - SK
130	13147DW	1 905	79,4
150	15147DW	1 996	83,2
160	16147DW	2 539	105,8
180	18147DW	2 284	95,2
200	20147DW	2 793	116,4



- prispôsobené pre zasunutie čiernej ocele bez zúženia
- zúženie je nutné odstrániť alebo použiť prechod 11XXSWOC

Skladová dostupnosť priemerov väčších ako DN 300 je na dotaz.

Všetky ceny sú uvedené bez DPH a dopravy

Tesnenie

3

DN	Kód produktu	Cena	€ - SK
80	08001DW	43	1,8
100	10001DW	54	2,3
130	13001DW	128	5,3
150	15001DW	128	5,3
160	16001DW	131	5,5
180	18001DW	128	5,3
200	20001DW	171	7,1
250	25001DW	192	8,0
300	30001DW	235	9,8



Spojovacia objímka

3

DN	Kód produktu	Cena	€ - SK
80	08070DW	145	6,0
100	10070DW	154	6,4
130	13070DW	161	6,7
150	15070DW	170	7,1
160	16070DW	174	7,3
180	18070DW	180	7,5
200	20070DW	206	8,6
250	25070DW	247	10,3
300	30070DW	275	11,5

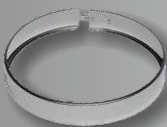

Spojovacia objímka s klipom

3

DN	Kód produktu	Cena	€ - SK
150	1570CDW	188	7,8
160	1670CDW	192	8,0
180	1870CDW	198	8,3
200	2070CDW	224	9,3



Zakladací diel s odtokom

3

DN	Kód produktu	Cena	€ - SK
80	08065DWJ	2 342	97,6
100	10065DWJ	2 507	104,5
130	13065DW	2 554	106,4
150	15065DW	2 691	112,1
160	16065DW	2 753	114,7
180	18065DW	2 828	117,8
200	20065DW	3 239	135,0
250	25065DW	3 677	153,2
300	30065DW	3 979	165,8



Podporný diel

3

DN	Kód produktu	Cena	€ - SK
80	08854DWJ	2 239	93,3
100	10854DWJ	2 348	97,8
130	13854DW	2 394	99,8
150	15854DW	2 502	104,3
160	16854DW	2 658	110,8
180	18854DW	2 850	118,8
200	20854DW	3 476	144,8
250	25854DW	6 146	256,1
300	30854DW	6 811	283,8



Skladová dostupnosť priemerov väčších ako DN 300 je na dotaz.

Golier nízky

3

DN	Kód produktu	Cena	€ - SK
80	08013DW	558	23,3
100	10013DW	605	25,2
130	13013DW	653	27,2
150	15013DW	708	29,5
160	16013DW	756	31,5
180	18013DW	924	38,5
200	20013DW	926	38,6
250	25013DW	1 535	64,0
300	30013DW	1 859	77,5



Golier vysoký

3

DN	Kód produktu	Cena	€ - SK
80	08V13DW	642	26,8
100	10V13DW	685	28,5
130	13V13DW	714	29,8
150	15V13DW	768	32,0
160	16V13DW	780	32,5
180	18V13DW	795	33,1
200	20V13DW	932	38,8
250	25V13DW	1 069	44,5
300	30V13DW	1 180	49,2



Golier pre zakrytie prestupu

3

DN	Kód produktu	Cena	€ - SK
130	13013DW/2	1 526	63,6
150	15013DW/2	1 610	67,1
160	16013DW/2	1 692	70,5
180	18013DW/2	1 857	77,4
200	20013DW/2	1 959	81,6
250	25013DW/2	2 120	88,3



- vonkajší priemer goliera +20 cm

Krycí plech pre zakrytie prestupu strechou 0°- 30°

3

DN	Kód produktu	Cena	€ - SK
80	08133DW	743	31,0
100	10133DW	773	32,2
130	13133DW	806	33,6
150	15133DW	837	34,9
160	16133DW	931	38,8
180	18133DW	949	39,5
200	20133DW	1 012	42,2
250	25133DW	1 140	47,5
300	30133DW	1 310	54,6



Krycí plech pre zakrytie prestupu stropom 30° - 45° ③

DN	Kód produktu	Cena	€ - SK
80	08132DW	743	31,0
100	10132DW	773	32,2
130	13132DW	806	33,6
150	15132DW	837	34,9
160	16132DW	931	38,8
180	18132DW	949	39,5
200	20132DW	1 012	42,2
250	25132DW	1 140	47,5
300	30132DW	1 310	54,6



Zakrytie prestupu hranaté G60 ③

DN	Kód produktu	Cena	€ - SK
130	13064DW	1 069	44,5
150	15064DW	1 124	46,8
160	16064DW	1 168	48,7
180	18064DW	1 207	50,3
200	20064DW	1 376	57,3

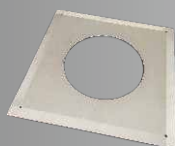

Parotesný krycí plech s tesnením ③

DN	Kód produktu	Cena	€ - SK
130	13644DW	921	38,4
150	15644DW	952	39,7
160	16644DW	1 206	50,3
180	18644DW	1 078	44,9
200	20644DW	1 121	46,7



Parotesný krycí plech s tesnením pre šikmé strechy ③

DN	Kód produktu	Cena	€ - SK
130	13645DW	1 191	49,6
150	15645DW	1 237	51,5
160	16645DW	1 568	65,3
180	18645DW	1 401	58,4
200	20645DW	1 495	62,3



Prestup horľavou konštrukciou - výška 350 mm ③

DN	Kód produktu	Cena	€ - SK
130	1314JDW	2 156	89,8
150	1514JDW	2 384	99,3
160	1614JDW	3 012	125,5
180	1814JDW	2 676	111,5
200	2014JDW	3 165	131,9



Prestup horľavou konštrukciou - výška 500 mm ③

DN	Kód produktu	Cena	€ - SK
130	1314KDW	3 772	157,2
150	1514KDW	4 171	173,8
160	1614KDW	5 271	219,6
180	1814KDW	4 683	195,1
200	2014KDW	5 539	230,8



- pre šikmé strechy

Zakladací diel s odtokom ③

DN	Kód produktu	Cena	€ - SK
80	08858DWJ	1 762	73,4
100	10858DWJ	2 172	90,5
130	13858DW	2 002	83,4
150	15858DW	2 090	87,1
160	16858DW	2 359	98,3
180	18858DW	2 472	103,0
200	20858DW	2 817	117,4
250	25858DW	5 664	236,0
300	30858DW	5 131	213,8

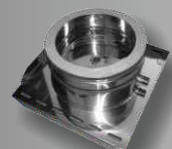

Konzola ③

DN	Kód produktu	Cena	€ - SK
80	08857SW	872	36,3
100	10857SW	1 016	42,3
110	11857SW	1 007	42,0
120	1A857SW	1 031	43,0
130	13857SW	1 167	48,6
140	14857SW	1 259	52,5
150	15857SW	1 444	60,2
160	16857SW	1 461	60,9
180	18857SW	1 533	63,9
200	20857SW	1 978	82,4
250	25857SW	2 347	97,8
300	30857SW	2 534	105,6

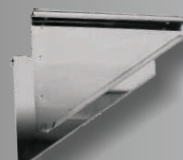

Konzola ③

délka	Kód produktu	Cena	€ - SK
500	UKOK1DW	1 793	74,7
750*	UKOK4DW	3 287	137,0
1000*	UKOK6DW	5 349	222,9



- * s podperou

Koleno 30°

③

DN	Kód produktu	Cena	€ - SK
80	08042DWJ	1 487	62,0
100	10042DWJ	1 595	66,5
130	13042DW	1 604	66,8
150	15042DW	1 755	73,1
160	16042DW	1 890	78,8
180	18042DW	2 056	85,7
200	20042DW	2 357	98,2
250	25042DW	2 780	115,8
300	30042DW	3 292	137,2



Inšpekčné koleno 87,5°

③

DN	Kód produktu	Cena	€ - SK
80	08431DWJ	3 444	143,5
100	10431DWJ	3 682	153,4
130	13431DW	4 162	173,4
150	15431DW	4 629	192,9
160	16431DW	4 914	204,8
180	18431DW	5 263	219,3
200	20431DW	6 076	253,2
250	25431DW	7 342	305,9
300	30431DW	8 699	362,5



Koleno 45°

③

DN	Kód produktu	Cena	€ - SK
80	08040DWJ	1 292	53,8
100	10040DWJ	1 387	57,8
130	13040DW	1 388	57,8
150	15040DW	1 543	64,3
160	16040DW	1 638	68,3
180	18040DW	1 755	73,1
200	20040DW	2 026	84,4
250	25040DW	2 448	102,0
300	30040DW	2 900	120,8



T - kus 90°

③

DN	Kód produktu	Cena	€ - SK
80	08031DWJ	2 219	92,5
100	10031DWJ	2 375	99,0
130	13031DW	2 418	100,8
150	15031DW	2 689	112,0
160	16031DW	3 163	131,8
180	18031DW	3 743	156,0
200	20031DW	4 196	174,8
250	25031DW	5 106	212,8
300	30031DW	5 950	247,9



Koleno 87°

③

DN	Kód produktu	Cena	€ - SK
80	08043DWJ	2 665	111,0
100	10043DWJ	2 851	118,8
130	13043DW	2 913	121,4
150	15043DW	3 241	135,0
160	16043DW	3 440	143,3
180	18043DW	3 684	153,5
200	20043DW	4 254	177,3
250	25043DW	5 140	214,2
300	30043DW	6 089	253,7



T - kus 93°

③

DN	Kód produktu	Cena	€ - SK
80	0831ADWJ	2 219	92,5
100	1031ADWJ	2 375	99,0
130	1331ADW	2 418	100,8
150	1531ADW	2 689	112,0
160	1631ADW	3 163	131,8
180	1831ADW	3 743	156,0
200	2031ADW	4 196	174,8
250	2531ADW	5 106	212,8
300	3031ADW	5 950	247,9



Koleno 90°

③

DN	Kód produktu	Cena	€ - SK
80	08433DWJ	2 665	111,0
100	10433DWJ	2 851	118,8
130	13433DW	2 913	121,4
150	15433DW	3 241	135,0
160	16433DW	3 440	143,3
180	18433DW	3 684	153,5
200	20433DW	4 254	177,3
250	25433DW	5 140	214,2
300	30433DW	6 089	253,7



Uzáver

③

DN	Kód produktu	Cena	€ - SK
80	08060DWJ	804	33,5
100	10060DWJ	874	36,4
130	13060DW	927	38,6
150	15060DW	863	36,0
160	16060DW	923	38,5
180	18060DW	996	41,5
200	20060DW	1 128	47,0
250	25060DW	1 327	55,3
300	30060DW	1 659	69,1



Skladová dostupnosť priemerov väčších ako DN 300 je na dotaz.

Uzáver s odtokom kondenzátu

③

DN	Kód produktu	Cena	€ - SK
80	08061DWJ	1 102	45,9
100	10061DWJ	1 192	49,7
130	13061DW	1 259	52,5
150	15061DW	1 195	49,8
160	16061DW	1 224	51,0
180	18061DW	1 260	52,5
200	20061DW	1 460	60,8
250	25061DW	1 725	71,9
300	30061DW	1 990	82,9



Čistiaci a revízny kus s dvierkami - podtlakový

③

DN	Kód produktu	Cena	€ - SK
130	13052DW	5 135	214,0
150	15052DW	5 256	219,0
160	16052DW	5 351	223,0
180	18052DW	5 467	227,8
200	20052DW	6 160	256,7
250	25052DW	6 914	288,1
300	30052DW	7 426	309,4



Čistiaci a revízny kus s dvierkami - pretlakový

③

DN	Kód produktu	Cena	€ - SK
80	08523DWJ	3 558	148,3
100	10523DWJ	3 811	158,8
130	13523DW	3 856	160,7
150	15523DW	4 262	177,6
160	16523DW	4 903	204,3
180	18523DW	5 686	236,9
200	20523DW	6 388	266,2
250	25523DW	7 719	321,6
300	30523DW	9 129	380,4



Kontrolný diel DW 440 mm

③

DN	Kód produktu	Cena	€ - SK
80	0824PDWJ	2 587	107,8
100	1024PDWJ	2 700	112,5
130	1324PDW	2 841	118,4
150	1524PDW	2 992	124,7
160	1624PDW	3 257	135,7
180	1824PDW	3 178	132,4
200	2024PDW	3 510	146,3
250	2524PDW	3 902	162,6
300	3024PDW	4 505	187,7



T-kus s protíahlym čistením

③

DN	Kód produktu	Cena	€ - SK
150	1552CDW	3 916	163,2
160	1652CDW	4 608	192,0
180	1852CDW	5 452	227,2
200	2052CDW	6 112	254,7



Prechod SW/DW

③

DN	Kód produktu	Cena	€ - SK
80	08105SW	565	23,5
100	10105SWJ	556	23,2
130	13105SW	682	28,4
150	15105SW	794	33,1
160	16105SW	906	37,8
180	18105SW	876	36,5
200	20105SW	1 099	45,8
250	25105SW	1 473	61,4
300	30105SW	1 782	74,3



Adaptér

③

DN	Kód produktu	Cena	€ - SK
80/100	Y0026DWJ	1 999	83,3
100/130	AG026DW	2 086	86,9
100/150	AH026DW	2 328	97,0
100/180	AJ026DW	2 629	109,5
100/200	AK026DW	3 020	125,8
130/150	CK026DW	2 328	97,0
150/180	DI026DW	2 644	110,2

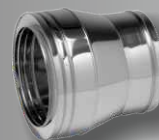

Redukcia

③

DN	Kód produktu	Cena	€ - SK
100/80	AD026DWJ	2 046	85,3

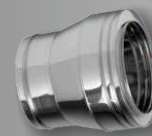

Tesnenie pod golier pri priechodke strechou

③

DN	Kód produktu	Cena	€ - SK
80-100	15J02SW	180	7,5
130	18J02SW	180	7,5
150	20J02SW	200	8,3
160-180	23J02SW	210	8,8
200	25J02SW	305	12,7
250	30J02SW	309	12,9
300	35J02SW	460	19,2



Komínová hlavica

③

DN	Kód produktu	Cena	€ - SK
80	08010DW	1 185	49,4
100	10010DW	1 264	52,7
130	13010DW	1 316	54,8
150	15010DW	1 540	64,2
160	16010DW	1 651	68,8
180	18010DW	1 786	74,4
200	20010DW	2 088	87,0
250	25010DW	2 746	114,4
300	30010DW	3 349	139,5



- vrátane objímok

Komínová hlavica s krytom proti dažďu

③

DN	Kód produktu	Cena	€ - SK
130	1312BDW	1 499	62,5
150	1512BDW	1 753	73,0
160	1612BDW	1 880	78,3
180	1812BDW	2 035	84,8
200	2012BDW	2 373	98,9



- ideálny pre použitie na dymovod s funkciou komína

- vrátane objímok

Prechod DW/SW

③

DN	Kód produktu	Cena	€ - SK
80	0816QDWJ	1 307	54,5
100	1016QDWJ	1 321	55,0
130	1316QDW	1 324	55,2
150	1516QDW	1 562	65,1
160	1616QDW	1 626	67,8
180	1816QDW	1 466	61,1
200	2016QDW	1 919	80,0
250	2516QDW	1 949	81,2
300	3016QDW	2 331	97,1



Kryt komína s prechodom SW/DW - dilatačný

③

DN	Kód produktu	Cena	€ - SK
130	1367SDW	1 840	76,7
150	1567SDW	2 240	93,3
160	1667SDW	2 302	95,9
180	1867SDW	2 480	103,3
200	2067SDW	3 000	125,0

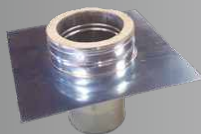

Skladová dostupnosť priemerov väčších ako DN 300 je na dotaz.

Ukončenie komína

③

DN	Kód produktu	Cena	€ - SK
80	08011DW	1 466	61,1
100	10011DW	1 564	65,2
130	13011DW	1 629	67,9
150	15011DW	1 749	72,9
160	16011DW	1 831	76,3
180	18011DW	1 931	80,5
200	20011DW	2 473	103,0
250	25011DW	2 955	123,1
300	30011DW	3 568	148,7



Priechodka strechou 5° / 30°

③

DN	Kód produktu	Cena	€ - SK
80	08018DW	2 841	118,4
100	10018DW	3 031	126,3
130	13018DW	3 157	131,5
150	15018DW	3 157	131,5
160	16018DW	3 665	152,7
180	18018DW	4 285	178,5
200	20018DW	4 285	178,5
250	25018DW	4 285	178,5
300	30018DW	6 120	255,0



Priechodka strechou 30° / 45°

③

DN	Kód produktu	Cena	€ - SK
80	08017DW	2 841	118,4
100	10017DW	3 031	126,3
130	13017DW	3 157	131,5
150	15017DW	3 157	131,5
160	16017DW	3 665	152,7
180	18017DW	4 285	178,5
200	20017DW	4 285	178,5
250	25017DW	4 285	178,5
300	30017DW	7 742	322,6



Kotviaca objímka

③

DN	Kód produktu	Cena	€ - SK
80	08080DW	395	16,5
100	10080DW	422	17,6
130	13080DW	439	18,3
150	15080DW	453	18,9
160	16080DW	459	19,1
180	18080DW	467	19,5
200	20080DW	508	21,2
250	25080DW	576	24,0
300	30080DW	658	27,4



Kotviaca objímka hladká 70 - 120 mm

3

DN	Kód produktu	Cena	€ - SK
80	08831DW	513	21,4
100	10831DW	535	22,3
130	13831DW	585	24,4
150	15831DW	648	27,0
160	16831DW	660	27,5
180	18831DW	672	28,0
200	20831DW	696	29,0



Kotviaca objímka hladká

3

DN	Kód produktu	Cena	€ - SK
80	08086DW	420	17,5
100	10086DW	448	18,7
130	13086DW	467	19,5
150	15086DW	467	19,5
160	16086DW	459	19,1
180	18086DW	494	20,6
200	20086DW	521	21,7
250	25086DW	604	25,2
300	30086DW	658	27,4

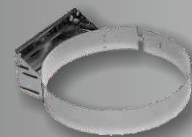

Kotviaca objímka 100 - 250 mm

3

DN	Kód produktu	Cena	€ - SK
80	08835DW	1 382	57,6
100	10835DW	1 474	61,4
130	13835DW	1 536	64,0
150	15835DW	1 585	66,0
160	16835DW	1 606	66,9
180	18835DW	1 632	68,0
200	20835DW	1 777	74,0
250	25835DW	2 016	84,0
300	30835DW	2 302	95,9



Kotviaca objímka 250 - 430 mm

3

DN	Kód produktu	Cena	€ - SK
80	08845DW	1 580	65,8
100	10845DW	1 685	70,2
130	13845DW	1 755	73,1
150	15845DW	1 812	75,5
160	16845DW	1 835	76,5
180	18845DW	1 865	77,7
200	20845DW	2 031	84,6
250	25845DW	2 304	96,0
300	30845DW	2 631	109,6



Kotviaca objímka 100 - 250 mm hladká

3

DN	Kód produktu	Cena	€ - SK
80	08836DW	1 469	61,2
100	10836DW	1 567	65,3
130	13836DW	1 632	68,0
150	15836DW	1 631	68,0
160	16836DW	1 676	69,8
180	18836DW	1 729	72,0
200	20836DW	1 824	76,0
250	25836DW	2 112	88,0
300	30836DW	2 302	95,9



Kotviaca objímka hladká 250 - 430 mm

3

DN	Kód produktu	Cena	€ - SK
80	08846DW	1 678	69,9
100	10846DW	1 791	74,6
130	13846DW	1 865	77,7
150	15846DW	1 864	77,7
160	16846DW	1 914	79,8
180	18846DW	1 975	82,3
200	20846DW	2 084	86,8
250	25846DW	2 413	100,5
300	30846DW	2 631	109,6

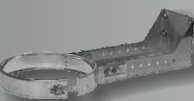

Kroková objímka

3

DN	Kód produktu	Cena	€ - SK
130	KO190	2 142	89,3
150	KO210	2 142	89,3
160	KO220	2 144	89,3
180	KO240	2 146	89,4
200	KO260	2 146	89,4

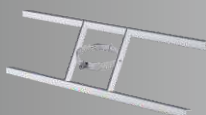

Predĺženie konzoly 835, 836, 845, 846

3

DN	Kód produktu	Cena	€ - SK
UNI	PK390W	1 164	48,5



Sada 2 teleskopických tyčí

3

	Kód produktu	Cena	€ - SK
UNI	STT2800	2 249	93,7

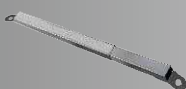

- slúži na kotvenie nadstrešnej časti izolovaného komína
- je možné skracovať podľa potreby
- dĺžka max 2800 mm

Objímky k teleskopickým tyčiam

3

DN	Kód produktu	Cena	€ - SK
130	OTT190	358	14,9
150	OTT210	366	15,3
160	OTT220	401	16,7
180	OTT240	378	15,8
200	OTT260	385	16,0



Skladová dostupnosť priemerov väčších ako DN 300 je na dotaz.

Všetky ceny sú uvedené bez DPH a dopravy

NEREZOVÝ TROJZLOŽKOVÝ LAKOVANÝ SYSTÉM DW **ricom** gas

S tesnením - kondenzačný kotol

Bez tesnenia - pevné palivá, suchá prevádzka

EN 1856-1 T200 P1 W V2 L50040 O(00)

EN 1856-1 T450 N1 W V2 L50040 O(40)

EN 1856-1 T600 N1 W V2 L50040 G(60)

Nerezový systém trojzložkový DWLAK		strana
A	ukončenie komína	29
B	predĺženie 440 mm	24
C	predĺženie 270 mm	24
D	t - kus 90°	27
E	čistiaci a revizný kus s dvierkami - podtlakový	27
F	zakladací diel s odtokom kondenzátu	27
G	konzola	26

Uľahčíte si prácu so zostavením a kalkuláciou komínového systému:

www.ricomgas.sk

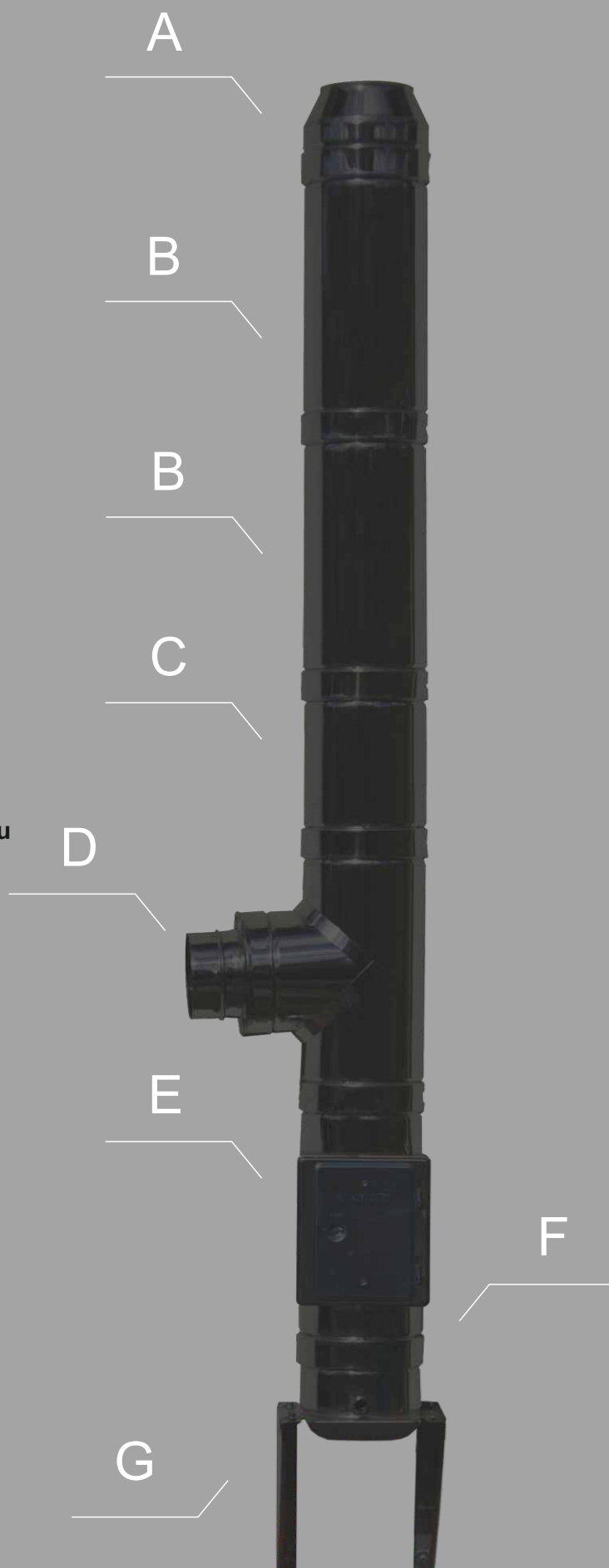

Ceny priemerov väčších ako DN 300 na vyžiadanie u obchodného zástupcu.

NEREZOVÝ TROJZLOŽKOVÝ LAKOVANÝ SYSTÉM DW **ricom** gas

Uvedené ceny sú za farbu RAL 9005 MAT. V prípade záujmu o inú farbu RAL účtujeme k zákazke jednorazový príplatok 42 EUR.

Rúra - 140 mm ③

DN	Kód produktu	Cena	€ - SK
80	08255DWJLAK	1 066	44,4
100	10255DWJLAK	1 280	53,3
130	13255DWLAK	1 371	57,1
150	15255DWLAK	1 480	61,7
160	16255DWLAK	1 553	64,7
180	18255DWLAK	1 643	68,5
200	20255DWLAK	1 865	77,7
250	25255DWLAK	2 316	96,5



Rúra - 270 mm ③

DN	Kód produktu	Cena	€ - SK
80	08025DWJLAK	1 146	47,8
100	10025DWJLAK	1 369	57,0
130	13025DWLAK	1 477	61,5
150	15025DWLAK	1 597	66,5
160	16025DWLAK	1 679	70,0
180	18025DWLAK	1 778	74,1
200	20025DWLAK	2 025	84,4
250	25025DWLAK	2 512	104,7
300	30025DWLAK	2 845	118,5



Rúra - 440 mm ③

DN	Kód produktu	Cena	€ - SK
80	08024DWJLAK	1 454	60,6
100	10024DWJLAK	1 757	73,2
130	13024DWLAK	1 898	79,1
150	15024DWLAK	2 049	85,4
160	16024DWLAK	2 133	88,9
180	18024DWLAK	2 235	93,1
200	20024DWLAK	2 567	107,0
250	25024DWLAK	3 149	131,2
300	30024DWLAK	3 752	156,3



Rúra - 940 mm ③

DN	Kód produktu	Cena	€ - SK
80	08020DWJLAK	2 261	94,2
100	10020DWJLAK	2 658	110,8
130	13020DWLAK	2 898	120,8
150	15020DWLAK	3 140	130,8
160	16020DWLAK	3 262	135,9
180	18020DWLAK	3 410	142,1
200	20020DWLAK	3 982	165,9
250	25020DWLAK	5 110	212,9
300	30020DWLAK	5 899	245,8



Rúra nastaviteľná 530 - 880 mm ③

DN	Kód produktu	Cena	€ - SK
80	08022DWJLAK	2 896	120,7
100	10022DWJLAK	3 486	145,3
130	13022DWLAK	3 777	157,4
150	15022DWLAK	4 079	170,0
160	16022DWLAK	4 214	175,6
180	18022DWLAK	4 380	182,5
200	20022DWLAK	5 013	208,9
250	25022DWLAK	6 341	264,2
300	30022DWLAK	7 064	294,3



- nie je určené pre horizontálnu inštaláciu pri aplikáciách s mokrou prevádzkou

Rúra nastaviteľná 350 - 530 mm ③

DN	Kód produktu	Cena	€ - SK
80	08023DWJLAK	2 329	97,0
100	10023DWJLAK	2 808	117,0
130	13023DWLAK	3 007	125,3
150	15023DWLAK	3 217	134,0
160	16023DWLAK	3 339	139,1
180	18023DWLAK	3 488	145,3
200	20023DWLAK	3 941	164,2
250	25023DWLAK	4 889	203,7
300	30023DWLAK	5 522	230,1



Prechodový diel 400 mm ③

DN	Kód produktu	Cena	€ - SK
130	13143DWLAK	1 908	79,5
150	15143DWLAK	1 997	83,2
160	16143DWLAK	2 081	86,7
180	18143DWLAK	2 177	90,7
200	20143DWLAK	2 496	104,0



- prispôsobené pre zasunutie čiernej ocele bez zúženía
- zúženía je nutné odstrániť alebo použiť prechod 11XXSWOC

Prechodový diel 900 mm ③

DN	Kód produktu	Cena	€ - SK
130	13147DWLAK	2 747	114,5
150	15147DWLAK	2 838	118,3
160	16147DWLAK	2 983	124,3
180	18147DWLAK	3 126	130,3
200	20147DWLAK	3 635	151,5

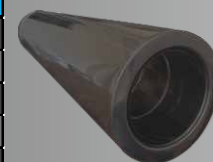

- prispôsobené pre zasunutie čiernej ocele bez zúženía
- zúženía je nutné odstrániť alebo použiť prechod 11XXSWOC

NEREZOVÝ TROJZLOŽKOVÝ LAKOVANÝ SYSTÉM DW **ricom** gas

Uvedené ceny sú za farbu RAL 9005 MAT. V prípade záujmu o inú farbu RAL účtujeme k zákazke jednorazový príplatok 42 EUR.

Tesnenie

③

DN	Kód produktu	Cena	€ - SK
80	08001DW	43	1,8
100	10001DW	54	2,3
130	13001DW	128	5,3
150	15001DW	128	5,3
160	16001DW	131	5,5
180	18001DW	128	5,3
200	20001DW	171	7,1
250	25001DW	192	8,0
300	30001DW	235	9,8



Golier pre zakrytie prestupu

③

DN	Kód produktu	Cena	€ - SK
130	13013DW/2LAK	2 053	85,5
150	15013DW/2LAK	2 137	89,0
160	16013DW/2LAK	2 218	92,4
180	18013DW/2LAK	2 384	99,3
200	20013DW/2LAK	2 544	106,0
250	25013DW/2LAK	2 911	121,3
300	30013DW/2LAK	3 160	131,7

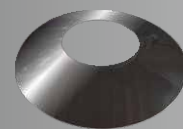

- vonkajší priemer goliera +20 cm

Kryt komína s prechodom SW/DW - dilatčný

③

DN	Kód produktu	Cena	€ - SK
130	1367SDWLAK	2 593	62,5
150	1567SDWLAK	2 682	65,0
160	1667SDWLAK	2 822	59,1
180	1867SDWLAK	2 978	69,5
200	2067SDWLAK	3 496	72,7

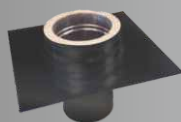

Golier nízky

③

DN	Kód produktu	Cena	€ - SK
80	08013DWLAK	730	30,4
100	10013DWLAK	917	38,2
130	13013DWLAK	1 049	43,7
150	15013DWLAK	1 087	45,3
160	16013DWLAK	1 113	46,4
180	18013DWLAK	1 215	50,6
200	20013DWLAK	1 265	52,7
250	25013DWLAK	1 710	71,3
300	30013DWLAK	2 453	102,2

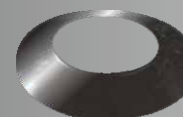

Zakladací diel s odtokom

③

DN	Kód produktu	Cena	€ - SK
80	08065DWJLAK	2 721	113,4
100	10065DWJLAK	3 033	126,4
130	13065DWLAK	3 080	128,3
150	15065DWLAK	3 217	134,0
160	16065DWLAK	3 279	136,6
180	18065DWLAK	3 355	139,8
200	20065DWLAK	3 765	156,9
250	25065DWLAK	4 372	182,2
300	30065DWLAK	4 673	194,7



Golier vysoký

③

DN	Kód produktu	Cena	€ - SK
80	08V13DWLAK	916	38,2
100	10V13DWLAK	1 085	45,2
130	13V13DWLAK	1 114	46,4
150	15V13DWLAK	1 168	48,7
160	16V13DWLAK	1 180	49,2
180	18V13DWLAK	1 195	49,8
200	20V13DWLAK	1 332	55,5
250	25V13DWLAK	1 596	66,5
300	30V13DWLAK	1 706	71,1



Podporný diel

③

DN	Kód produktu	Cena	€ - SK
80	08854DWJLAK	2 534	105,6
100	10854DWJLAK	2 769	115,4
130	13854DWLAK	2 815	117,3
150	15854DWLAK	2 923	121,8
160	16854DWLAK	3 079	128,3
180	18854DWLAK	3 271	136,3
200	20854DWLAK	3 897	162,4
250	25854DWLAK	6 694	278,9
300	30854DWLAK	7 358	306,6

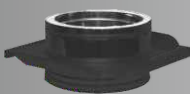

Krycí plech pre zakrytie prestupu stropom 0° - 30°

③

DN	Kód produktu	Cena	€ - SK
80	08133DWLAK	1 270	52,9
100	10133DWLAK	1 325	55,2
130	13133DWLAK	1 517	63,2
150	15133DWLAK	1 572	65,5
160	16133DWLAK	1 631	68,0
180	18133DWLAK	1 689	70,4
200	20133DWLAK	1 783	74,3
250	25133DWLAK	1 665	69,4
300	30133DWLAK	1 926	80,3



NEREZOVÝ TROJZLOŽKOVÝ LAKOVANÝ SYSTÉM DW **ricom** gas

Uvedené ceny sú za farbu RAL 9005 MAT. V prípade záujmu o inú farbu RAL účtujeme k zákazke jednorazový príplatok 42 EUR.

Krycí plech pre zakrytie prestupu stropom 30°- 45° ③

DN	Kód produktu	Cena	€ - SK
80	08132DWLAK	1 270	52,9
100	10132DWLAK	1 305	54,4
130	13132DWLAK	1 333	55,5
150	15132DWLAK	1 560	65,0
160	16132DWLAK	1 587	66,1
180	18132DWLAK	1 716	71,5
200	20132DWLAK	1 752	73,0
250	25132DWLAK	1 786	74,4
300	30132DWLAK	1 926	80,3



Zakrytie prestupu hranaté G60 ③

DN	Kód produktu	Cena	€ - SK
130	13064DWLAK	1 596	66,5
150	15064DWLAK	1 651	68,8
160	16064DWLAK	1 687	70,3
180	18064DWLAK	1 733	72,2
200	20064DWLAK	1 902	79,3

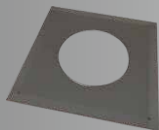

Zakladací diel s odtokom ③

DN	Kód produktu	Cena	€ - SK
80	08858DWJLAK	2 145	89,4
100	10858DWJLAK	2 486	103,6
130	13858DWLAK	2 399	100,0
150	15858DWLAK	2 491	103,8
160	16858DWLAK	2 664	111,0
180	18858DWLAK	2 760	115,0
200	20858DWLAK	3 279	136,6
250	25858DWLAK	6 032	251,3
300	30858DWLAK	5 816	242,3

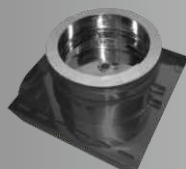

Konzola ③

DN	Kód produktu	Cena	€ - SK
80	08857DWLAK	2 125	88,5
100	10857DWLAK	1 888	78,7
130	13857DWLAK	2 201	91,7
150	15857DWLAK	2 433	101,4
160	16857DWLAK	2 435	101,5
180	18857DWLAK	2 456	102,3
200	20857DWLAK	2 468	102,8
250	25857DWLAK	2 802	116,8
300	30857DWLAK	3 046	126,9

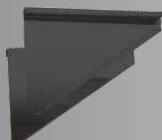

Konzola ③

délka	Kód produktu	Cena	€ - SK
500	UKOK1DWLAK	2 467	102,8
750*	UKOK4DWLAK	4 045	168,5
1000*	UKOK6DWLAK	6 191	258,0



Spojovacia objímka ③

DN	Kód produktu	Cena	€ - SK
80	08070DWLAK	292	12,2
100	10070DWLAK	365	15,2
130	13070DWLAK	371	15,5
150	15070DWLAK	380	15,8
160	16070DWLAK	385	16,0
180	18070DWLAK	390	16,3
200	20070DWLAK	417	17,4
250	25070DWLAK	521	21,7
300	30070DWLAK	548	22,8

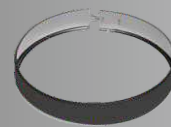

Koleno 30° ③

DN	Kód produktu	Cena	€ - SK
80	08042DWJLAK	1 782	74,3
100	10042DWJLAK	2 016	84,0
130	13042DWLAK	2 025	84,4
150	15042DWLAK	2 176	90,7
160	16042DWLAK	2 311	96,3
180	18042DWLAK	2 477	103,2
200	20042DWLAK	2 778	115,8
250	25042DWLAK	3 327	138,6
300	30042DWLAK	3 839	160,0

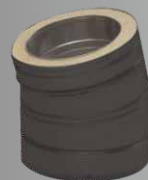

Koleno 45° ③

DN	Kód produktu	Cena	€ - SK
80	08040DWJLAK	1 587	66,1
100	10040DWJLAK	1 808	75,3
130	13040DWLAK	1 809	75,4
150	15040DWLAK	1 964	81,8
160	16040DWLAK	2 060	85,8
180	18040DWLAK	2 176	90,7
200	20040DWLAK	2 447	102,0
250	25040DWLAK	2 995	124,8
300	30040DWLAK	3 447	143,6



NEREZOVÝ TROJZLOŽKOVÝ LAKOVANÝ SYSTÉM DW **ricom** gas

Uvedené ceny sú za farbu RAL 9005 MAT. V prípade záujmu o inú farbu RAL účtujeme k zákazke jednorazový príplatok 42 EUR.

Koleno 87°

③

DN	Kód produktu	Cena	€ - SK
80	08043DWJLAK	3 107	129,5
100	10043DWJLAK	3 483	145,1
130	13043DWLAK	3 545	147,7
150	15043DWLAK	3 873	161,4
160	16043DWLAK	4 072	169,7
180	18043DWLAK	4 316	179,8
200	20043DWLAK	4 885	203,5
250	25043DWLAK	5 961	248,4
300	30043DWLAK	6 910	287,9



T- kus 93°

③

DN	Kód produktu	Cena	€ - SK
80	0831ADWJLAK	2 745	114,4
100	1031ADWJLAK	3 133	130,5
130	1331ADWLAK	3 176	132,3
150	1531ADWLAK	3 447	143,6
160	1631ADWLAK	3 921	163,4
180	1831ADWLAK	4 501	187,5
200	2031ADWLAK	4 954	206,4
250	2531ADWLAK	6 095	254,0
300	3031ADWLAK	6 939	289,1



Koleno 90°

③

DN	Kód produktu	Cena	€ - SK
80	08433DWJLAK	3 107	129,5
100	10433DWJLAK	3 483	145,1
130	13433DWLAK	3 545	147,7
150	15433DWLAK	3 873	161,4
160	16433DWLAK	4 072	169,7
180	18433DWLAK	4 316	179,8
200	20433DWLAK	4 885	203,5
250	25433DWLAK	5 961	248,4
300	30433DWLAK	6 910	287,9



Uzáver

③

DN	Kód produktu	Cena	€ - SK
80	08060DWJLAK	1 036	43,2
100	10060DWJLAK	1 190	49,6
130	13060DWLAK	1 243	51,8
150	15060DWLAK	1 179	49,1
160	16060DWLAK	1 239	51,6
180	18060DWLAK	1 311	54,6
200	20060DWLAK	1 444	60,2
250	25060DWLAK	1 748	72,8
300	30060DWLAK	2 080	86,7



Inšpekčné koleno 87,5°

③

DN	Kód produktu	Cena	€ - SK
80	08431DWJLAK	3 886	161,9
100	10431DWJLAK	4 313	179,7
130	13431DWLAK	4 794	199,8
150	15431DWLAK	5 261	219,2
160	16431DWLAK	5 546	231,1
180	18431DWLAK	5 895	245,6
200	20431DWLAK	6 708	279,5
250	25431DWLAK	8 163	340,1
300	30431DWLAK	9 520	396,7



Uzáver s odtokom kondenzátu

③

DN	Kód produktu	Cena	€ - SK
80	08061DWJLAK	1 334	55,6
100	10061DWJLAK	1 507	62,8
130	13061DWLAK	1 575	65,6
150	15061DWLAK	1 511	63,0
160	16061DWLAK	1 540	64,2
180	18061DWLAK	1 576	65,7
200	20061DWLAK	1 776	74,0
250	25061DWLAK	2 146	89,4
300	30061DWLAK	2 411	100,5



T- kus 90°

③

DN	Kód produktu	Cena	€ - SK
80	08031DWJLAK	2 745	114,4
100	10031DWJLAK	3 133	130,5
130	13031DWLAK	3 176	132,3
150	15031DWLAK	3 447	143,6
160	16031DWLAK	3 921	163,4
180	18031DWLAK	4 501	187,5
200	20031DWLAK	4 954	206,4
250	25031DWLAK	6 095	254,0
300	30031DWLAK	6 939	289,1



Čistiaci a revízny kus s dvierkami - pretlakový

③

DN	Kód produktu	Cena	€ - SK
130	13052DWLAK	5 893	245,5
150	15052DWLAK	6 014	250,6
160	16052DWLAK	6 109	254,5
180	18052DWLAK	6 225	259,4
200	20052DWLAK	6 918	288,3
250	25052DWLAK	7 903	329,3
300	30052DWLAK	8 416	350,7



NEREZOVÝ TROJZLOŽKOVÝ LAKOVANÝ SYSTÉM DW **ricom** gas

Uvedené ceny sú za farbu RAL 9005 MAT. V prípade záujmu o inú farbu RAL účtujeme k zákazke jednorazový príplatok 42 EUR.

Čistiaci a revízny kus okrúhly - pretlakový ③

DN	Kód produktu	Cena	€ - SK
80	08523DWJLAK	4 463	186,0
100	10523DWJLAK	5 095	212,3
130	13523DWLAK	5 140	214,2
150	15523DWLAK	5 547	231,1
160	16523DWLAK	6 187	257,8
180	18523DWLAK	6 970	290,4
200	20523DWLAK	7 672	319,7
250	25523DWLAK	9 403	391,8
300	30523DWLAK	10 813	450,5



Redukcia ③

DN	Kód produktu	Cena	€ - SK
100/80	AD026DWJLAK	2 467	102,8

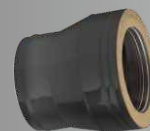

Kontrolný diel DW 440 mm ③

DN	Kód produktu	Cena	€ - SK
80	0824PDWJLAK	3 029	126,2
100	1024PDWJLAK	3 332	138,8
130	1324PDWJLAK	3 473	144,7
150	1524PDWJLAK	3 624	151,0
160	1624PDWJLAK	3 889	162,0
180	1824PDWJLAK	3 810	158,8
200	2024PDWJLAK	4 141	172,5
250	2524PDWJLAK	4 723	196,8
300	3024PDWJLAK	5 326	221,9



Komínová hlavica ③

DN	Kód produktu	Cena	€ - SK
80	08010DWLAK	1 774	73,9
100	10010DWLAK	2 106	87,8
130	13010DWLAK	2 158	89,9
150	15010DWLAK	2 382	99,3
160	16010DWLAK	2 493	103,9
180	18010DWLAK	2 629	109,5
200	20010DWLAK	2 930	122,1
250	25010DWLAK	3 841	160,0
300	30010DWLAK	4 443	185,1



- vrátane objímok

Prechod DW/SW ③

DN	Kód produktu	Cena	€ - SK
80	08105SWLAK	686	28,6
100	10105SWJLAK	782	32,6
130	13105SWLAK	902	37,6
150	15105SWLAK	991	41,3
160	16105SWLAK	1 057	44,0
180	18105SWLAK	1 128	47,0
200	20105SWLAK	1 225	51,0
250	25105SWLAK	1 663	69,3
300	30105SWLAK	2 177	90,7



- použiteľné pre aplikáciu s maximálnou teplotnou triedou T120

Komínová hlavica s krytom proti dažďu ③

DN	Kód produktu	Cena	€ - SK
130	1312BDWLAK	1 879	78,3
150	1512BDWLAK	2 126	88,6
160	1612BDWLAK	2 240	93,3
180	1812BDWLAK	2 400	100,0
200	2012BDWLAK	2 728	113,7



Adaptér ③

DN	Kód produktu	Cena	€ - SK
80/100	Y0026DWJLAK	2 390	99,6
100/130	AG026DWLAK	2 507	104,5
100/150	AH026DWLAK	2 749	114,5
100/180	AJ026DWLAK	3 050	127,1
100/200	AK026DWLAK	3 442	143,4
130/150	CK026DWLAK	2 749	114,5
150/180	DI026DWLAK	2 859	119,1



NEREZOVÝ TROJZLOŽKOVÝ LAKOVANÝ SYSTÉM DW **ricom** gas

Uvedené ceny sú za farbu RAL 9005 MAT. V prípade záujmu o inú farbu RAL účtujeme k zákazke jednorazový príplatok 42 EUR.

Ukončenie komína ③

DN	Kód produktu	Cena	€ - SK
80	08011DWLAK	1 761	73,4
100	10011DWLAK	1 985	82,7
130	13011DWLAK	2 050	85,4
150	15011DWLAK	2 170	90,4
160	16011DWLAK	2 252	93,8
180	18011DWLAK	2 352	98,0
200	20011DWLAK	2 894	120,6
250	25011DWLAK	3 503	146,0
300	30011DWLAK	4 115	171,5



Kotviaca objímka ③

DN	Kód produktu	Cena	€ - SK
80	08080DWLAK	585	24,4
100	10080DWLAK	696	29,0
130	13080DWLAK	713	29,7
150	15080DWLAK	727	30,3
160	16080DWLAK	733	30,5
180	18080DWLAK	740	30,8
200	20080DWLAK	782	32,6
250	25080DWLAK	934	38,9
300	30080DWLAK	1 016	42,3



Priechodka strechou 5° / 30° vr. goliera ③

DN	Kód produktu	Cena	€ - SK
80	08018DWLAK	3 746	156,1
100	10018DWLAK	4 315	179,8
130	13018DWLAK	4 441	185,0
150	15018DWLAK	4 441	185,0
160	16018DWLAK	4 949	206,2
180	18018DWLAK	5 569	232,0
200	20018DWLAK	5 569	232,0
250	25018DWLAK	5 955	248,2
300	30018DWLAK	7 790	324,6

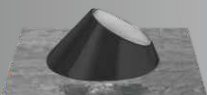

+



Kotviaca objímka hladká ③

DN	Kód produktu	Cena	€ - SK
80	08086DWLAK	609	25,4
100	10086DWLAK	721	30,0
130	13086DWLAK	740	30,8
150	15086DWLAK	740	30,8
160	16086DWLAK	733	30,5
180	18086DWLAK	768	32,0
200	20086DWLAK	795	33,1
250	25086DWLAK	962	40,1
300	30086DWLAK	1 016	42,3



Priechodka strechou 30° / 45° vr. goliera ③

DN	Kód produktu	Cena	€ - SK
80	08017DWLAK	3 746	156,1
100	10017DWLAK	4 315	179,8
130	13017DWLAK	4 441	185,0
150	15017DWLAK	4 441	185,0
160	16017DWLAK	4 949	206,2
180	18017DWLAK	5 569	232,0
200	20017DWLAK	5 569	232,0
250	25017DWLAK	5 955	248,2
300	30017DWLAK	9 412	392,2

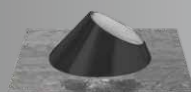

+



Kotviaca objímka 100 - 250 mm ③

DN	Kód produktu	Cena	€ - SK
80	08835DWLAK	1 782	74,3
100	10835DWLAK	2 043	85,1
130	13835DWLAK	2 104	87,7
150	15835DWLAK	2 154	89,8
160	16835DWLAK	2 174	90,6
180	18835DWLAK	2 200	91,7
200	20835DWLAK	2 346	97,8
250	25835DWLAK	2 753	114,7
300	30835DWLAK	3 039	126,6



Tesnenie pod golier pri priechodke strechou ③

DN	Kód produktu	Cena	€ - SK
80-100	15J02SW	180	7,5
130	18J02SW	180	7,5
150	20J02SW	200	8,3
160-180	23J02SW	210	8,8
200	25J02SW	305	12,7
250	30J02SW	309	12,9
300	35J02SW	460	19,2



Kotviaca objímka hladká 100 - 250 mm ③

DN	Kód produktu	Cena	€ - SK
80	08836DWLAK	1 869	77,9
100	10836DWLAK	2 135	89,0
130	13836DWLAK	2 200	91,7
150	15836DWLAK	2 200	91,7
160	16836DWLAK	2 244	93,5
180	18836DWLAK	2 297	95,7
200	20836DWLAK	2 392	99,7
250	25836DWLAK	2 849	118,7
300	30836DWLAK	3 039	126,6



NEREZOVÝ TROJZLOŽKOVÝ LAKOVANÝ SYSTÉM DW **ricom** gas

Uvedené ceny sú za farbu RAL 9005 MAT. V prípade záujmu o inú farbu RAL účtujeme k zákazke jednorazový príplatok 42 EUR.

Kotviaca objímka 250 - 430 mm

③

DN	Kód produktu	Cena	€ - SK
80	08845DWLAK	2 064	86,0
100	10845DWLAK	2 359	98,3
130	13845DWLAK	2 429	101,2
150	15845DWLAK	2 486	103,6
160	16845DWLAK	2 509	104,5
180	18845DWLAK	2 539	105,8
200	20845DWLAK	2 705	112,7
250	25845DWLAK	3 188	132,8
300	30845DWLAK	3 515	146,5



Kroková objímka

③

DN	Kód produktu	Cena	€ - SK
130	KO190	2 142	89,3
150	KO210	2 142	89,3
160	KO220	2 144	89,3
180	KO240	2 146	89,4
200	KO260	2 146	89,4



- nie je lakovaná, dodáva sa v prírodnej farbe nerez

Kotviaca objímka hladká 250 - 430 mm

③

DN	Kód produktu	Cena	€ - SK
80	08846DWLAK	2 163	90,1
100	10846DWLAK	2 464	102,7
130	13846DWLAK	2 539	105,8
150	15846DWLAK	2 538	105,8
160	16846DWLAK	2 588	107,8
180	18846DWLAK	2 648	110,3
200	20846DWLAK	2 758	114,9
250	25846DWLAK	3 298	137,4
300	30846DWLAK	3 515	146,5



Objímky k teleskopickým tyčiam

③

DN	Kód produktu	Cena	€ - SK
130	OTT190LAK	516	21,5
150	OTT210LAK	524	21,8
160	OTT220LAK	544	22,7
180	OTT240LAK	554	23,1
200	OTT260LAK	562	23,4



Súprava 2 teleskopických tyčí

③

	Kód produktu	Cena	€ - SK
UNI	STT2800LAK	4 217	175,7

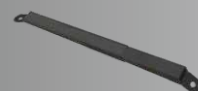

- slúži na kotvenie nadstrešnej časti izolovaného komína
- je možné skracovať podľa potreby
- dĺžka max 2800 mm

Kotviaca objímka 70 - 120 mm hladká

③

DN	Kód produktu	Cena	€ - SK
80	08831DWLAK	967	40,3
100	10831DWLAK	1 174	48,9
130	13831DWLAK	1 199	50,0
150	15831DWLAK	1 216	50,7
160	16831DWLAK	1 229	44,7
180	18831DWLAK	1 240	51,2
200	20831DWLAK	1 264	52,7



Predĺženie konzolí 835, 836, 845, 846

③

DN	Kód produktu	Cena	€ - SK
UNI	PK390W	1 501	62,5

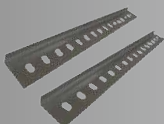

EN 1856-1 T600 N1 D V3 L50060 G60

Nerezový systém trojzložkový DW6		strana
A	ukončenie komína	33
B	predĺženie 440 mm	32
C	predĺženie 270 mm	32
D	t - kus 90°	32
E	čistiaci a revízny kus s dvierkami - podtlakový	33
F	podporný diel	33
G	uzáver s odvodom kondenzátu	32
H	konzola	33

Uľahčíte si prácu so zostavením a kalkuláciou komínového systému:

www.ricomgas.sk

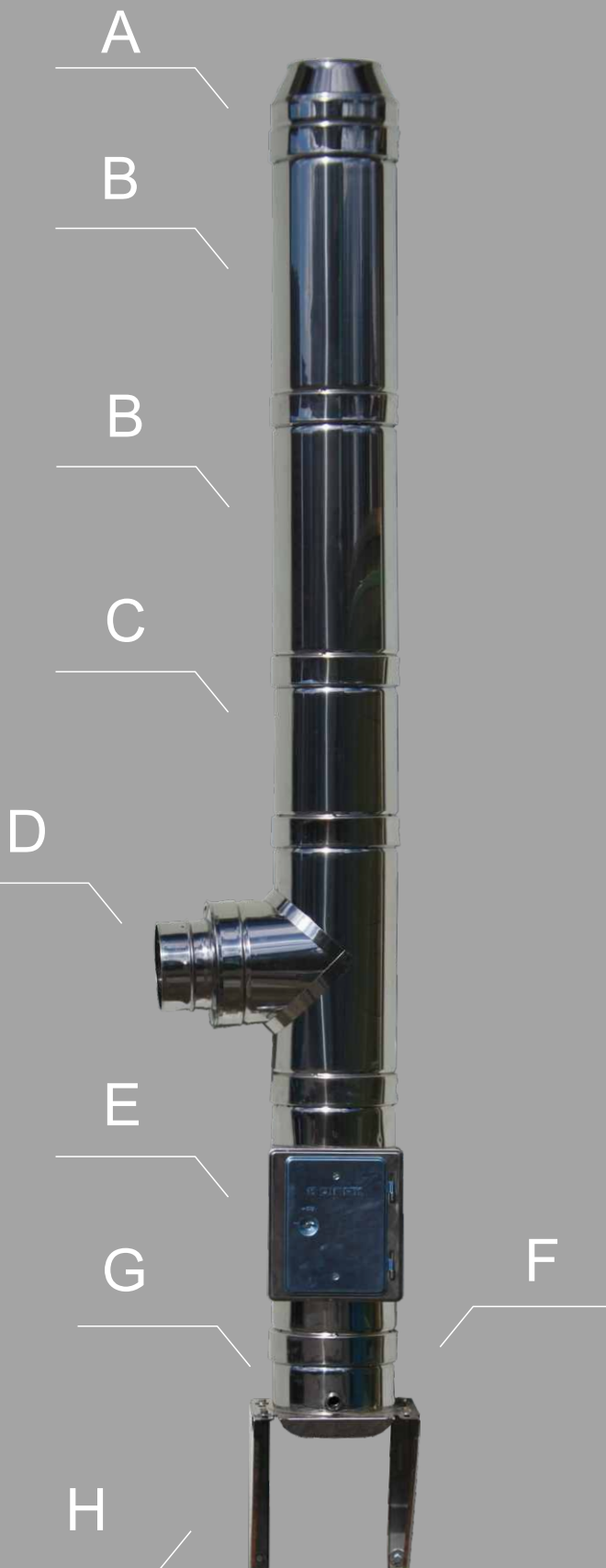

Rúra - 270 mm

③

DN	Kód	Cena	€ - SK
150	15025DW6	1 353	56,4
160	16025DW6	1 446	60,3
180	18025DW6	1 561	65,0
200	20025DW6	1 844	76,8
250	25025DW6	2 260	94,2
300	30025DW6	2 642	110,1



Koleno 45°

③

DN	Kód	Cena	€ - SK
150	15040DW6	1 775	74,0
160	16040DW6	1 884	78,5
180	18040DW6	2 018	84,1
200	20040DW6	2 330	97,1
250	25040DW6	2 815	117,3
300	30040DW6	3 335	139,0



Rúra - 440 mm

③

DN	Kód	Cena	€ - SK
150	15024DW6	1 630	67,9
160	16024DW6	1 726	71,9
180	18024DW6	1 844	76,8
200	20024DW6	2 225	92,7
250	25024DW6	2 677	111,5
300	30024DW6	3 370	140,4



Koleno revízne 87°

③

DN	Kód	Cena	€ - SK
150	15431DW6	5 324	221,8
160	16431DW6	5 651	235,5
180	18431DW6	6 053	252,2
200	20431DW6	6 987	291,1
250	25431DW6	8 444	351,8
300	30431DW6	10 004	416,8



Rúra - 940 mm

③

DN	Kód	Cena	€ - SK
150	15020DW6	2 642	110,1
160	16020DW6	2 782	115,9
180	18020DW6	2 953	123,0
200	20020DW6	3 611	150,5
250	25020DW6	4 617	192,4
300	30020DW6	5 525	230,2



T- kus 90°

③

DN	Kód	Cena	€ - SK
150	15031DW6	3 092	128,8
160	16031DW6	3 638	151,6
180	18031DW6	4 305	179,4
200	20031DW6	4 825	201,0
250	25031DW6	5 871	244,6
300	30031DW6	6 842	285,1



Koleno 30°

③

DN	Kód	Cena	€ - SK
150	15042DW6	2 018	84,1
160	16042DW6	2 174	90,6
180	18042DW6	2 364	98,5
200	20042DW6	2 711	113,0
250	25042DW6	3 196	133,2
300	30042DW6	3 785	157,7



Uzáver s odtokom kondenzátu

③

DN	Kód	Cena	€ - SK
150	15061DW6	1 374	57,3
160	16061DW6	1 408	58,7
180	18061DW6	1 449	60,4
200	20061DW6	1 679	70,0
250	25061DW6	1 984	82,7
300	30061DW6	2 288	95,3



Komínová hlavica

③

DN	Kód	Cena	€ - SK
150	15010DW6	1 771	73,8
160	16010DW6	1 899	79,1
180	18010DW6	2 054	85,6
200	20010DW6	2 401	100,0
250	25010DW6	3 158	131,6
300	30010DW6	3 851	160,5



Ukončenie komína

③

DN	Kód produktu	Cena	€ - SK
150	15011DW6	2 011	83,8
160	16011DW6	2 105	87,7
180	18011DW6	2 220	92,5
200	20011DW6	2 844	118,5



Prechod SW/DW

③

DN	Kód	Cena	€ - SK
150	15105SW6	1 082	45,1
160	16105SW6	1 178	49,1
180	18105SW6	1 161	48,4
200	20105SW6	1 235	51,5
250	25105SW6	1 600	66,7
300	30105SW6	2 182	90,9



Podporný diel

③

DN	Kód	Cena	€ - SK
150	15854DW6	2 925	121,9
160	16854DW6	3 205	133,5
180	18854DW6	3 295	137,3
200	20854DW6	2 956	123,2
250	25854DW6	6 426	267,8
300	30854DW6	6 426	267,8



Spojovacia objímka

③

DN	Kód	Cena	€ - SK
150	15070DW	170	7,1
160	16070DW	174	7,3
180	18070DW	180	7,5
200	20070DW	206	8,6
250	25070DW	247	10,3
300	30070DW	275	11,5

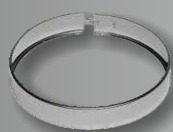

Konzola

③

délka	Kód produktu	Cena	€ - SK
500	UKOK1DW	1 793	74,7
750*	UKOK4DW	3 287	137,0
1000*	UKOK6DW	5 349	222,9

- * vr. vzpery



Konzola

③

DN	Kód	Cena	€ - SK
150	15857DW	2 064	86,0
160	16857DW	2 046	85,3
180	18857DW	2 187	91,1
200	20857DW	1 636	68,2
250	25857DW	1 986	82,8
300	30857DW	1 851	77,1



Čistiaci a revízny kus s dvierkami - podtlakový

③

DN	Kód	Cena	€ - SK
150	15052DW6	6 044	251,8
160	16052DW6	6 154	256,4
180	18052DW6	6 287	262,0
200	20052DW6	7 084	295,2
250	25052DW6	7 951	331,3
300	30052DW6	8 540	355,8



EN 1856-1 T600 N1 D V3 L50060 G60

Nerezový systém trojzložkový DW6LAK		strana
A	ukončenie komína	37
B	rúra 440 mm	35
C	rúra 270 mm	35
D	t - kus 90°	37
E	čistiaci a revízny kus s dvierkami - podtlakový	37
F	podporný diel	35
G	konzola	36

Uľahčíte si prácu so zostavením a kalkuláciou komínového systému:

www.ricomgas.sk

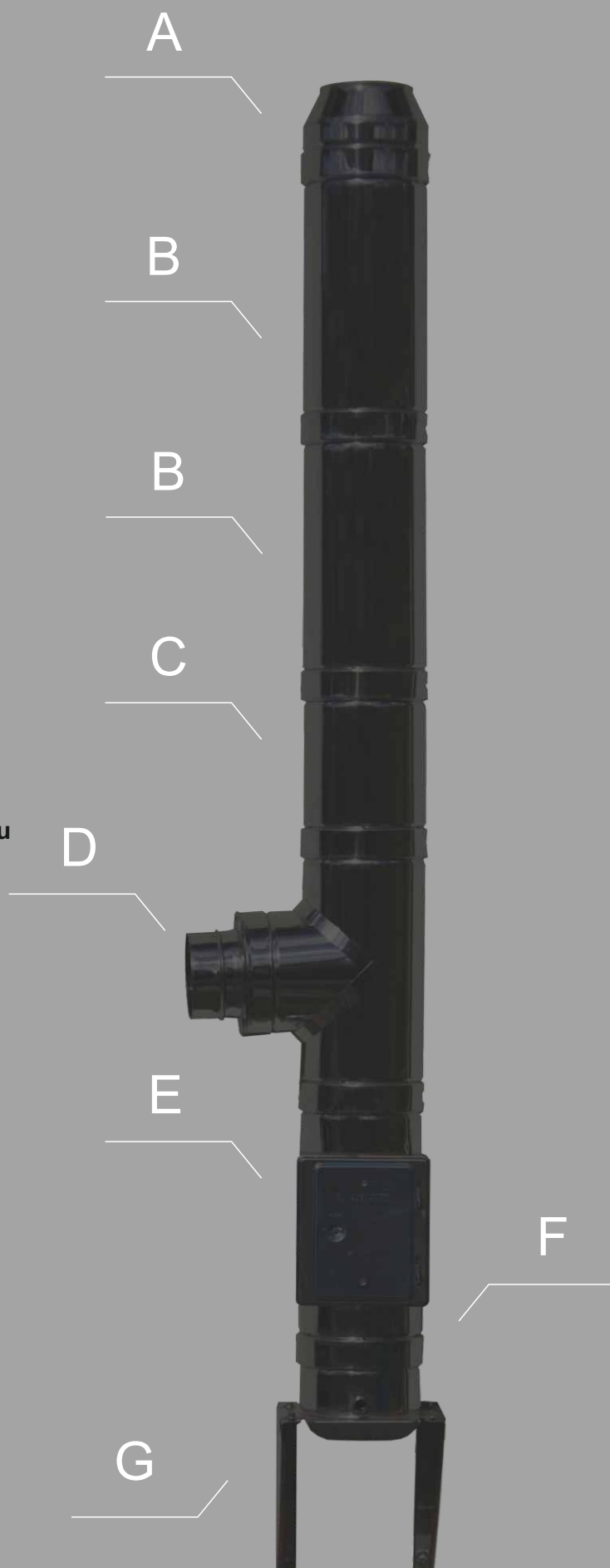

Ceny priemerov väčších ako DN 300 na vyžiadanie u obchodného zástupcu.

Uvedené ceny sú za farbu RAL 9005 MAT. V prípade záujmu o inú farbu RAL účtujeme k zákazke jednorazový príplatok 42 EUR.

Rúra - 270 mm

③

DN	Kód produktu	Cena	€ - SK
150	15025DW6LAK	1 774	73,9
160	16025DW6LAK	1 867	77,8
180	18025DW6LAK	1 982	82,6
200	20025DW6LAK	2 265	94,4
250	25025DW6LAK	2 807	117,0
300	30025DW6LAK	3 190	132,9



Tesnenie

③

DN	Kód produktu	Cena	€ - SK
80	08001DW	43	1,8
100	10001DW	54	2,3
130	13001DW	128	5,3
150	15001DW	128	5,3
160	16001DW	131	5,5
180	18001DW	128	5,3
200	20001DW	171	7,1
250	25001DW	192	8,0
300	30001DW	235	9,8



Rúra - 440 mm

③

DN	Kód produktu	Cena	€ - SK
150	15024DW6LAK	2 262	94,3
160	16024DW6LAK	2 358	98,3
180	18024DW6LAK	2 476	103,2
200	20024DW6LAK	2 857	119,0
250	25024DW6LAK	3 498	145,8
300	30024DW6LAK	4 191	174,6



Kryt komína s prechodom SW/DW - dilatačný

③

DN	Kód produktu	Cena	€ - SK
150	1567SDW6LAK	2 998	124,9
160	1667SDW6LAK	3 150	131,3
180	1867SDW6LAK	3 334	138,9
200	2067SDW6LAK	3 921	163,4

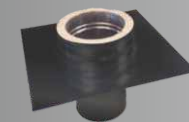

Rúra - 940 mm

③

DN	Kód produktu	Cena	€ - SK
150	15020DW6LAK	3 484	145,2
160	16020DW6LAK	3 624	151,0
180	18020DW6LAK	3 796	158,2
200	20020DW6LAK	4 453	185,5
250	25020DW6LAK	5 712	238,0
300	30020DW6LAK	6 619	275,8



Podporný diel

③

DN	Kód produktu	Cena	€ - SK
150	15854DW6LAK	3 194	133,1
160	16854DW6LAK	3 329	138,7
180	18854DW6LAK	3 347	139,5
200	20854DW6LAK	4 390	182,9
250	25854DW6LAK	6 973	290,5
300	30854DW6LAK	8 230	342,9



Rúra nastaviteľná 350 - 530 mm

③

DN	Kód produktu	Cena	€ - SK
150	15023DW6LAK	3 548	147,8
160	16023DW6LAK	3 689	153,7
180	18023DW6LAK	3 860	160,8
200	20023DW6LAK	4 381	182,5



- nie je určené pre horizontálnu inštaláciu pri aplikáciách s mokrou prevádzkou

Prechod SW/DW

③

DN	Kód produktu	Cena	€ - SK
150	15105SW6LAK	1 240	51,7
160	16105SW6LAK	1 314	54,8
180	18105SW6LAK	1 426	59,4
200	20105SW6LAK	1 487	62,0
250	25105SW6LAK	1 936	80,7
300	30105SW6LAK	2 519	105,0



- použiteľné pre aplikáciu s maximálnou teplotnou triedou T120.

Uvedené ceny sú za farbu RAL 9005 MAT. V prípade záujmu o inú farbu RAL účtujeme k zákazke jednorazový príplatok 42 EUR.

Golier nízky

③

DN	Kód produktu	Cena	€ - SK
150	15013DWLAK	1 087	45,3
160	16013DWLAK	1 113	46,4
180	18013DWLAK	1 215	50,6
200	20013DWLAK	1 265	52,7
250	25013DWLAK	1 710	71,3
300	30013DWLAK	2 453	102,2

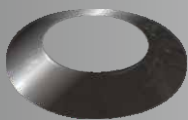

Golier vysoký

③

DN	Kód produktu	Cena	€ - SK
150	15V13DWLAK	1 168	48,7
160	16V13DWLAK	1 180	49,2
180	18V13DWLAK	1 195	49,8
200	20V13DWLAK	1 332	55,5
250	25V13DWLAK	1 596	66,5
300	30V13DWLAK	1 706	71,1



Golier nízky pre zakrytie prestupu

③

DN	Kód produktu	Cena	€ - SK
150	15013DW/2LAK	2 137	89,0
160	16013DW/2LAK	2 218	92,4
180	18013DW/2LAK	2 384	99,3
200	20013DW/2LAK	2 544	106,0
250	25013DW/2LAK	2 911	121,3
300	30013DW/2LAK	3 160	131,7

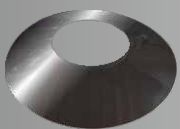

- vonkajší priemer goliera +20 cm

Konzola

③

DN	Kód produktu	Cena	€ - SK
150	15857DWLAK	2 433	101,4
160	16857DWLAK	2 435	101,5
180	18857DWLAK	2 456	102,3
200	20857DWLAK	2 468	102,8
250	25857DWLAK	2 802	116,8
300	30857DWLAK	3 046	126,9

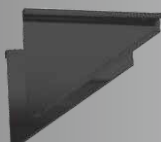

Konzola

③

délka	Kód produktu	Cena	€ - SK
500	UKOK1DWLAK	2 467	102,8
750*	UKOK4DWLAK	4 045	168,5
1000*	UKOK6DWLAK	6 191	258,0



Spojovacia objímka

③

DN	Kód produktu	Cena	€ - SK
150	15070DWLAK	380	15,8
160	16070DWLAK	385	16,0
180	18070DWLAK	390	16,3
200	20070DWLAK	417	17,4
250	25070DWLAK	521	21,7
300	30070DWLAK	548	22,8



Koleno 30°

③

DN	Kód produktu	Cena	€ - SK
150	15042DW6LAK	2 439	101,6
160	16042DW6LAK	2 595	108,1
180	18042DW6LAK	2 785	116,0
200	20042DW6LAK	3 132	130,5
250	25042DW6LAK	3 744	156,0
300	30042DW6LAK	4 333	180,5

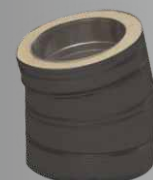

Koleno 45°

③

DN	Kód produktu	Cena	€ - SK
150	15040DW6LAK	2 196	91,5
160	16040DW6LAK	2 305	96,0
180	18040DW6LAK	2 439	101,6
200	20040DW6LAK	2 751	114,6
250	25040DW6LAK	3 362	140,1
300	30040DW6LAK	3 882	161,8



Uvedené ceny sú za farbu RAL 9005 MAT. V prípade záujmu o inú farbu RAL účtujeme k zákazke jednorazový príplatok 42 EUR.

Inšpekčné koleno 87,5°

③

DN	Kód produktu	Cena	€ - SK
150	15431DW6LAK	5 955	248,1
160	16431DW6LAK	6 283	261,8
180	18431DW6LAK	6 684	278,5
200	20431DW6LAK	7 619	317,5
250	25431DW6LAK	9 265	386,0
300	30431DW6LAK	10 825	451,0



Čistiaci a revízny kus s dvierkami - podtlakový

③

DN	Kód produktu	Cena	€ - SK
150	15052DW6LAK	6 802	283,4
160	16052DW6LAK	6 912	288,0
180	18052DW6LAK	7 045	293,5
200	20052DW6LAK	7 842	326,8
250	25052DW6LAK	8 940	372,5
300	30052DW6LAK	9 530	397,1



T - kus 90°

③

DN	Kód produktu	Cena	€ - SK
150	15031DW6LAK	3 850	160,4
160	16031DW6LAK	4 396	183,2
180	18031DW6LAK	5 062	210,9
200	20031DW6LAK	5 583	232,6
250	25031DW6LAK	6 861	285,9
300	30031DW6LAK	7 831	326,3



Komínová hlavica

③

DN	Kód produktu	Cena	€ - SK
150	15010DW6LAK	2 613	108,9
160	16010DW6LAK	2 741	114,2
180	18010DW6LAK	2 896	120,7
200	20010DW6LAK	3 243	135,1
250	25010DW6LAK	4 252	177,2
300	30010DW6LAK	4 946	206,1



- vrátane objímok

Uzáver

③

DN	Kód produktu	Cena	€ - SK
150	15060DW6LAK	1 309	54,5
160	16060DW6LAK	1 377	57,4
180	18060DW6LAK	1 461	60,9
200	20060DW6LAK	1 613	67,2
250	25060DW6LAK	1 947	81,1
300	30060DW6LAK	2 329	97,0



Ukončenie komína

③

DN	Kód produktu	Cena	€ - SK
150	15011DW6LAK	2 433	101,4
160	16011DW6LAK	2 526	105,3
180	18011DW6LAK	2 641	110,0
200	20011DW6LAK	3 265	136,0



Uzáver s odtokom kondenzátu

③

DN	Kód produktu	Cena	€ - SK
150	15061DW6LAK	1 690	70,4
160	16061DW6LAK	1 724	71,8
180	18061DW6LAK	1 765	73,5
200	20061DW6LAK	1 994	83,1
250	25061DW6LAK	2 405	100,2
300	30061DW6LAK	2 709	112,9



Kotviaca objímka

③

DN	Kód produktu	Cena	€ - SK
150	15080DWLAK	727	30,3
160	16080DWLAK	733	30,5
180	18080DWLAK	740	30,8
200	20080DWLAK	782	32,6
250	25080DWLAK	934	38,9
300	30080DWLAK	1 016	42,3



Uvedené ceny sú za farbu RAL 9005 MAT. V prípade záujmu o inú farbu RAL účtujeme k zákazke jednorazový príplatok 42 EUR.

Kotviaca objímka hladká

③

DN	Kód produktu	Cena	€ - SK
150	15086DWLAK	740	30,8
160	16086DWLAK	733	30,5
180	18086DWLAK	768	32,0
200	20086DWLAK	795	33,1
250	25086DWLAK	962	40,1
300	30086DWLAK	1 016	42,3



Kotviaca objímka 100 - 250 mm

③

DN	Kód produktu	Cena	€ - SK
150	15835DWLAK	2 154	89,8
160	16835DWLAK	2 174	90,6
180	18835DWLAK	2 200	91,7
200	20835DWLAK	2 346	97,8
250	25835DWLAK	2 753	114,7
300	30835DWLAK	3 039	126,6



Priechodka strechou 5° / 30° vr. goliera

③

DN	Kód produktu	Cena	€ - SK
150	15018DWLAK	4 441	185,0
160	16018DWLAK	4 949	206,2
180	18018DWLAK	5 569	232,0
200	20018DWLAK	5 569	232,0
250	25018DWLAK	5 864	244,3
300	30018DWLAK	7 699	320,8

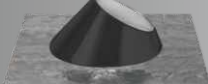

+



Kotviaca objímka hladká 100 - 250 mm

③

DN	Kód produktu	Cena	€ - SK
150	15836DWLAK	2 200	91,7
160	16836DWLAK	2 244	93,5
180	18836DWLAK	2 297	95,7
200	20836DWLAK	2 392	99,7
250	25836DWLAK	2 849	118,7
300	30836DWLAK	3 039	126,6



Priechodka strechou 30° / 45° vr. goliera

③

DN	Kód produktu	Cena	€ - SK
150	15017DWLAK	4 441	185,0
160	16017DWLAK	4 949	206,2
180	18017DWLAK	5 569	232,0
200	20017DWLAK	5 569	232,0
250	25017DWLAK	5 864	244,3
300	30017DWLAK	9 321	388,4

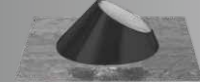

+



Kotviaca objímka 250 - 430 mm

③

DN	Kód produktu	Cena	€ - SK
150	15845DWLAK	2 486	103,6
160	16845DWLAK	2 509	104,5
180	18845DWLAK	2 539	105,8
200	20845DWLAK	2 705	112,7
250	25845DWLAK	3 188	132,8
300	30845DWLAK	3 515	146,5



Priechodka strechou rovná

③

DN	Kód produktu	Cena	€ - SK
150	15019DWLAK	3 920	163,3
160	16019DWLAK	4 426	184,4
180	18019DWLAK	5 044	210,2
200	20019DWLAK	5 044	210,2
250	25019DWLAK	5 339	222,5
300	30019DWLAK	7 207	300,3

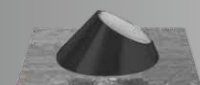

+



Kotviaca objímka hladká 250 - 430 mm

③

DN	Kód produktu	Cena	€ - SK
150	15846DWLAK	2 538	105,8
160	16846DWLAK	2 588	107,8
180	18846DWLAK	2 648	110,3
200	20846DWLAK	2 758	114,9
250	25846DWLAK	3 298	137,4
300	30846DWLAK	3 515	146,5



Uvedené ceny sú za farbu RAL 9005 MAT. V prípade záujmu o inú farbu RAL účtujeme k zákazke jednorazový príplatok 42 EUR.

Predĺženie konzolí 835, 836, 845, 846

③

DN	Kód produktu	Cena	€ - SK
UNI	PK390W	1 501	62,5

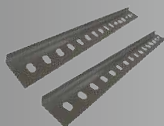

Objímky k teleskopickým tyčiam

③

DN	Kód produktu	Cena	€ - SK
130	OTT190LAK	516	21,5
150	OTT210LAK	524	21,8
160	OTT220LAK	544	22,7
180	OTT240LAK	554	23,1
200	OTT260LAK	562	23,4



Súprava 2 teleskopických tyčí

③

DN	Kód produktu	Cena	€ - SK
UNI	STT2800LAK	4 217	175,7

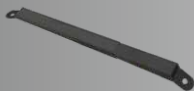

- slúži na kotvenie nadstrešnej časti izolovaného komína
- je možné skracovať podľa potreby
- dĺžka max 2800 mm

Kroková objímka

③

DN	Kód produktu	Cena	€ - SK
130	KO190	2 142	89,3
150	KO210	2 142	89,3
160	KO220	2 144	89,3
180	KO240	2 146	89,4
200	KO260	2 146	89,4



- nie je lakovaná, dodáva sa v prírodnej farbe nerez

NEREZOVÝ SYSTÉM JEDNODUCHÝ S8V2

ricom
gas

Pevné palivá, suchá prevádzka

Plne kompatibilný so systémom S10

EN 1856-2 T600 N1 D Vm L50080 G

Nerezový systém jednoduchý S8V2		strana
A	komínová hlavica UNI	45
B	čistiaci prvok	45
C	predĺženie 950mm	41
D	T - kus 90°	42
E	čistiaci diel + tubus s dvierkami	44
F	uzáver	43

Uľahčíte si prácu so zostavením a kalkuláciou
komínového systému:

www.ricomgas.sk

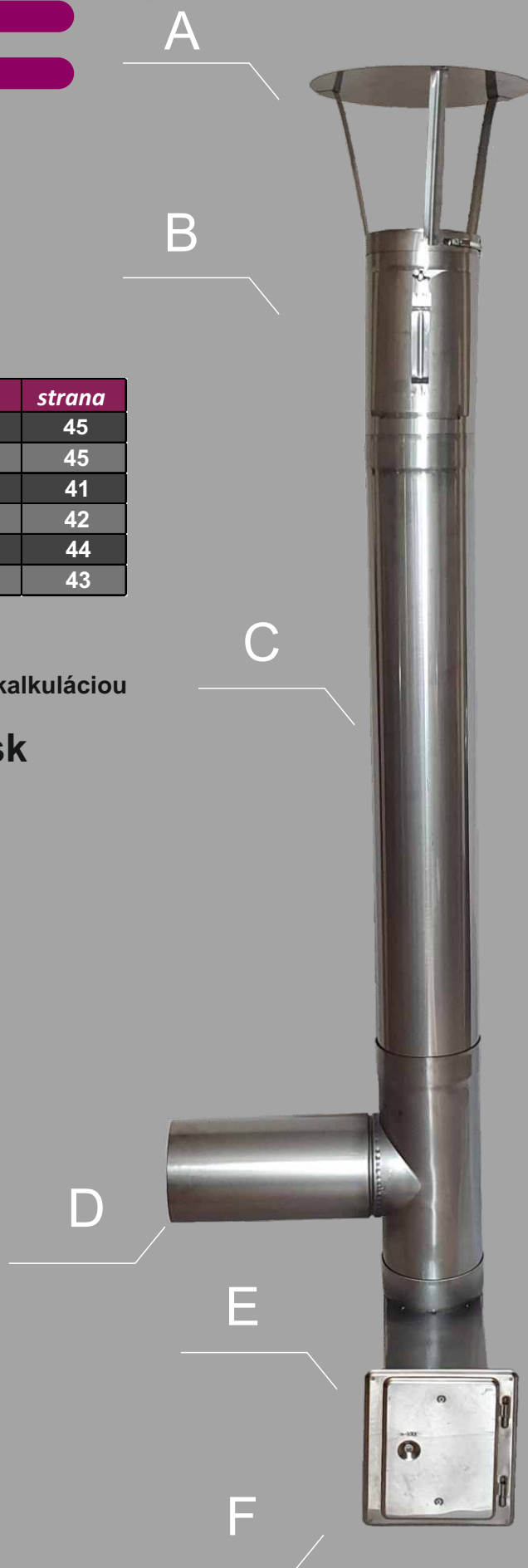

Rúra - 200 mm

(19)

DN	Kód produktu	Cena	€ - SK
130	13025S8V2	272	11,3
140	14025S8V2	293	12,2
150	15025S8V2	312	13,0
160	16025S8V2	331	13,8
170	17025S8V2	351	14,6
180	18025S8V2	370	15,4
200	20025S8V2	408	17,0



Rúra s očkami na spúšťanie 950 mm

(19)

DN	Kód produktu	Cena	€ - SK
130	13203S8V2	1 096	45,7
140	14203S8V2	1 182	49,3
150	15203S8V2	1 262	52,6
160	16203S8V2	1 343	56,0
170	17203S8V2	1 426	59,4
180	18203S8V2	1 506	62,8
200	20203S8V2	1 669	69,5



Rúra - 450 mm

(19)

DN	Kód produktu	Cena	€ - SK
130	13024S8V2	532	22,2
140	14024S8V2	572	23,8
150	15024S8V2	611	25,5
160	16024S8V2	649	27,0
170	17024S8V2	688	28,7
180	18024S8V2	726	30,3
200	20024S8V2	804	33,5



Rúra pre skúšanie priechodnosti komínového telesa

(6)

DN	Kód produktu	Cena	€ - SK
140	14025SUTEST	1 116	46,5
150	15025SUTEST	1 152	48,0
160	16025SUTEST	1 188	49,5
170	17025SUTEST	1 228	51,2
180	18025SUTEST	1 264	52,7
200	20025SUTEST	1 344	56,0



Rúra - 950 mm

(19)

DN	Kód produktu	Cena	€ - SK
130	13020S8V2	1 042	43,4
140	14020S8V2	1 123	46,8
150	15020S8V2	1 199	50,0
160	16020S8V2	1 276	53,2
170	17020S8V2	1 355	56,5
180	18020S8V2	1 431	59,6
200	20020S8V2	1 586	66,1

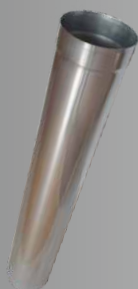

Koleno 15°

(19)

DN	Kód produktu	Cena	€ - SK
130	13044S8V2	401	16,7
140	14044S8V2	401	16,7
150	15044S8V2	417	17,4
160	16044S8V2	433	18,0
170	17044S8V2	452	18,8
180	18044S8V2	477	19,9
200	20044S8V2	523	21,8



Vsuvka - 450 mm

(6)

DN	Kód produktu	Cena	€ - SK
130	13VSU24S8V2	532	22,2
140	14VSU24S8V2	572	23,8
150	15VSU24S8V2	611	25,5
160	16VSU24S8V2	649	27,0
170	17VSU24S8V2	688	28,7
180	18VSU24S8V2	726	30,3
200	20VSU24S8V2	804	33,5



Koleno 30°

(19)

DN	Kód produktu	Cena	€ - SK
130	13042S8V2	458	19,1
140	14042S8V2	475	19,8
150	15042S8V2	496	20,7
160	16042S8V2	516	21,5
170	17042S8V2	536	22,3
180	18042S8V2	558	23,3
200	20042S8V2	600	25,0



Vsuvka - 950 mm

(6)

DN	Kód produktu	Cena	€ - SK
140	14VSU20S8V2	1 123	46,8
150	15VSU20S8V2	1 199	50,0
150	16VSU20S8V2	1 276	53,2
170	17VSU20S8V2	1 355	56,5
180	18VSU20S8V2	1 431	59,6
200	20VSU20S8V2	1 586	66,1

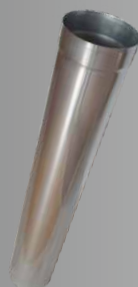

Koleno 45°

(19)

DN	Kód produktu	Cena	€ - SK
130	13040S8V2	648	27,0
140	14040S8V2	675	28,1
150	15040S8V2	718	29,9
160	16040S8V2	724	30,2
170	17040S8V2	743	31,0
180	18040S8V2	775	32,3
200	20040S8V2	924	38,5



Koleno 90°

19

DN	Kód produktu	Cena	€ - SK
130	13433S8V2	954	39,8
140	14433S8V2	996	41,5
150	15433S8V2	1 076	44,8
160	16433S8V2	1 115	46,5
170	17433S8V2	1 158	48,3
180	18433S8V2	1 193	49,7
200	20433S8V2	1 285	53,5



T- kus 45°

19

DN	Kód produktu	Cena	€ - SK
130	13032S8V2	1 514	63,1
140	14032S8V2	1 439	60,0
150	15032S8V2	1 497	62,4
160	16032S8V2	1 722	71,8
170	17032S8V2	1 818	75,8
180	18032S8V2	1 900	79,2
200	20032S8V2	2 099	87,5



Koleno 90° s kontrolným otvorom

19

DN	Kód produktu	Cena	€ - SK
130	13432S8V2	1 163	48,5
140	14432S8V2	1 194	49,8
150	15432S8V2	1 279	53,3
160	16432S8V2	1 323	55,1
170	17432S8V2	1 391	58,0
180	18432S8V2	1 446	60,3
200	20432S8V2	1 569	65,4



T- kus 90°

19

DN	Kód produktu	Cena	€ - SK
130	13B31S8V2	966	40,3
140	14B31S8V2	1 024	42,7
150	15B31S8V2	1 084	45,2
160	16B31S8V2	1 139	47,5
170	17B31S8V2	1 201	50,0
180	18B31S8V2	1 404	58,5
200	20B31S8V2	1 615	67,3



- dĺžka odbočky 245 mm
- výška T-kusu 280 mm

Koleno prestaviteľné 0 - 45°

6

DN	Kód produktu	Cena	€ - SK
130	13045S8V2	1 110	46,3
140	14045S8V2	1 185	49,4
150	15045S8V2	1 258	52,4
160	16045S8V2	1 333	55,5
170	17045S8V2	1 467	61,1
180	18045S8V2	1 589	66,2
200	20045S8V2	1 748	72,8



T- kus so vsuvnou odbočkou

19

DN	Kód produktu	Cena	€ - SK
130	13033S8V2	1 104	46,0
140	14033S8V2	1 177	49,0
150	15033S8V2	1 231	51,3
160	16033S8V2	1 285	53,5
170	17033S8V2	1 409	58,7
180	18033S8V2	1 560	65,0
200	20033S8V2	1 770	73,8



- odbočka je možné zasunúť do rúry

Koleno prestaviteľné 0 - 90°

6

DN	Kód produktu	Cena	€ - SK
130	13041S8V2	1 498	62,4
140	14041S8V2	1 597	66,5
150	15041S8V2	1 719	71,6
160	16041S8V2	1 759	73,3
170	17041S8V2	1 864	77,7
180	18041S8V2	1 949	81,2
200	20041S8V2	2 460	102,5



T- kus s bajonetom

19

DN	Kód produktu	Cena	€ - SK
130	13031S8V2BAJ	1 305	54,4
140	14031S8V2BAJ	1 323	55,1
150	15031S8V2BAJ	1 367	57,0
160	16031S8V2BAJ	1 409	58,7
170	17031S8V2BAJ	1 459	60,8
180	18031S8V2BAJ	1 498	62,4
200	20031S8V2BAJ	1 586	66,1



- dĺžka odbočky 190 mm
- výška T-kusu 280 mm

Koleno prestaviteľné 0 - 90° s kontrolným otvorom

6

DN	Kód produktu	Cena	€ - SK
130	13041S8V2KO	2 303	96,0
140	14041S8V2KO	2 433	101,4
150	15041S8V2KO	2 454	102,3
160	16041S8V2KO	2 464	102,7
170	17041S8V2KO	2 699	112,5
180	18041S8V2KO	2 754	114,8
200	20041S8V2KO	3 165	131,9



T-kus bajonetový redukovaný

6

DN	Kód produktu	Cena	€ - SK
140/130	14013031S8V2BAJ	1 613	67,2
150/130	15013031S8V2BAJ	1 635	68,1
150/140	15014031S8V2BAJ	1 657	69,0
160/130	16013031S8V2BAJ	1 673	69,7
160/140	16014031S8V2BAJ	1 685	70,2
160/150	16015031S8V2BAJ	1 699	70,8
170/130	17013031S8V2BAJ	1 709	71,2
170/140	17014031S8V2BAJ	1 718	71,6
170/150	17015031S8V2BAJ	1 728	72,0
170/160	17016031S8V2BAJ	1 737	72,4
180/130	18013031S8V2BAJ	1 748	72,8
180/140	18014031S8V2BAJ	1 759	73,3
180/150	18015031S8V2BAJ	1 768	73,7
180/160	18016031S8V2BAJ	1 778	74,1
180/170	18017031S8V2BAJ	1 788	74,5
200/130	20013031S8V2BAJ	1 832	76,3
200/140	20014031S8V2BAJ	1 860	77,5
200/150	20015031S8V2BAJ	1 887	78,6
200/160	20016031S8V2BAJ	1 946	81,1
200/170	20017031S8V2BAJ	1 945	81,0
200/180	20018031S8V2BAJ	1 986	82,8



T-Kus 90° - hrdlo pre flex 0,4 mm

6

DN	Kód produktu	Cena	€ - SK
130	13F31S8V2	966	40,3
140	14F31S8V2	1 024	42,7
150	15F31S8V2	1 084	45,2
160	16F31S8V2	1 139	47,5
170	17F31S8V2	1 201	50,0
180	18F31S8V2	1 404	58,5
200	20F31S8V2	1 615	67,3
250	25F31S8V2	1 836	76,5



Adaptér ťahaný

19

DN	Kód produktu	Cena	€ - SK
130/140	28130140SU	192	8,0
130/150	28130150SU	192	8,0
130/160	28130160SU	352	14,7
140/150	28140150SU	205	8,5
140/160	28140160SU	205	8,5
150/160	28150160SU	219	9,1
150/180	28150180SU	229	9,5
160/180	28160180SU	250	10,4
170/180	28170180SU	193	8,0
180/200	28180200SU	260	10,8



T- kus 90° s prevlečenou odbočkou

6

DN	Kód produktu	Cena	€ - SK
120	12035S8V2	1 048	43,7
130	13035S8V2	1 134	47,3
140	14035S8V2	1 192	49,7
150	15035S8V2	1 252	52,2
160	16035S8V2	1 307	54,5
170	17035S8V2	1 369	57,0
180	18035S8V2	1 572	65,5
200	20035S8V2	1 783	74,3



Adaptér ťahaný - vkladný

19

DN	Kód produktu	Cena	€ - SK
130/140	28130140VLSU	192	8,0
130/150	28130150VLSU	197	8,2
140/160	28140160VLSU	165	6,9
150/160	28150160VLSU	222	9,3
160/180	28160180VLSU	250	10,4
180/200	28180200VLSU	203	8,5



Redukovaný T-kus 90° s odbočkou S8V2

6

DN	Kód produktu	Cena	€ - SK
140/130	14013031S8V2	1 160	48,3
150/80	15008031S8V2	1 160	48,3
150/120	15012031S8V2	1 160	48,3
150/130	15013031S8V2	1 160	48,3
150/140	15014031S8V2	1 180	49,2
160/120	16012031S8V2	1 180	49,2
160/130	16013031S8V2	1 210	50,4
160/150	16015031S8V2	1 244	51,8
170/150	17015031S8V2	1 249	52,0
170/160	17016031S8V2	1 299	54,1
180/130	18013031S8V2	1 299	54,1
180/150	18015031S8V2	1 299	54,1
180/160	18016031S8V2	1 423	59,3
200/150	20015031S8V2	1 538	64,1
200/160	20016031S8V2	1 538	64,1
200/180	20018031S8V2	1 538	64,1
250/150	25015031S8V2	1 560	65,0
250/200	25020031S8V2	1 892	78,8



Adaptér varený

19

DN	Kód produktu	Cena	€ - SK
130/150	30130150SU	672	28,0
130/160	30130160SU	684	28,5
130/180	30130180SU	710	29,6
130/200	30130200SU	735	30,6
140/160	30140160SU	618	25,8
140/180	30140180SU	638	26,6
140/200	30140200SU	699	29,1
150/180	30150180SU	739	30,8
150/200	30150200SU	798	33,3
150/250	30150250SU	679	28,3
160/200	30160200SU	627	26,1
180/250	30180250SU	677	28,2



Adaptér varený - vložený

19

DN	Kód produktu	Cena	€ - SK
150/180	30150180VLSU	654	27,3



- stranu s väčším DN je možné zasunúť do rúry

Uzáver so spodným odtokom

19

DN	Kód produktu	Cena	€ - SK
130	13061SS8V2	673	28,0
140	14061SS8V2	678	28,3
150	15061SS8V2	683	28,5
160	16061SS8V2	701	29,2
170	17061SS8V2	724	30,2
180	18061SS8V2	735	30,6
200	20061SS8V2	772	32,2



Uzáver s bočným odtokom

19

DN	Kód produktu	Cena	€ - SK
130	13061S8V2	380	15,8
140	14061S8V2	409	17,0
150	15061S8V2	415	17,3
160	16061S8V2	433	18,0
170	17061S8V2	439	18,3
180	18061S8V2	446	18,6
200	20061S8V2	497	20,7



Uzáver

19

DN	Kód produktu	Cena	€ - SK
130	13060S8V2	264	11,0
140	14060S8V2	284	11,8
150	15060S8V2	314	13,1
160	16060S8V2	332	13,8
170	17060S8V2	334	13,9
180	18060S8V2	365	15,2
200	20060S8V2	412	17,2



Uzáver s madlom

6

DN	Kód produktu	Cena	€ - SK
130	13060MS8V2	356	14,8
140	14060MS8V2	360	15,0
150	15060MS8V2	364	15,2
160	16060MS8V2	380	15,8
170	17060MS8V2	406	16,9
180	18060MS8V2	410	17,1
200	20060MS8V2	443	18,5



Čistiaci diel bez dvierok

6

DN	Kód produktu	Cena	€ - SK
130	13520S8V2	1 083	45,1
140	14520S8V2	1 121	46,7
150	15520S8V2	1 181	49,2
160	16520S8V2	1 195	49,8
170	17520S8V2	1 202	50,1
180	18520S8V2	1 203	50,1
200	20520S8V2	1 204	50,2



Predĺženie čistiaceho dielu s dvierkami

6

DN	Kód produktu	Cena	€ - SK
	TUBDRN20	2 064	86,0
	TUBDRN40	2 459	102,5
	TUBDRN50	2 769	115,4



- dĺžky tubusov predĺženia
 TUBDRNS8V2-20 = 20 cm
 -40 = 40 cm
 -50 = 50 cm.

Predĺženie čistiaceho dielu s dvierkami

6

s dvierkovým regulátorom ťahu - L = 200mm

DN	Kód produktu	Cena	€ - SK
	TUBDRN20REG	4 236	176,5



Predĺženie čistiaceho dielu s dvierkami - biele

6

DN	Kód produktu	Cena	€ - SK
	TUBDRZNB20	2 211	92,1
	TUBDRZNB40	2 606	108,6
	TUBDRZNB50	2 916	121,5



- dĺžky tubusov predĺženia
 TUBDRNS8V2-20 = 20 cm
 -40 = 40 cm
 -50 = 50 cm.

Komínové dvierka nerez, pozink, biele

6

	Kód produktu	Cena	€ - SK
nerez	DRN1420S10	1 623	67,6
pozink	DRZN1420	1 309	54,5
biele	DRZNB1420	1 777	74,0



Náhradné tesnenie do komínových dvierok

6

DN	Kód produktu	Cena	€ - SK
UNI	TDU	196	8,2



- sada obsahuje šróby

Čistiaci prvok

6

DN	Kód produktu	Cena	€ - SK
130	13050S8V2	621	25,9
140	14050S8V2	660	27,5
150	15050S8V2	696	29,0
160	16050S8V2	732	30,5
170	17050S8V2	769	32,0
180	18050S8V2	805	33,5
200	20050S8V2	878	36,6



Čistiaci prvok s pružinkou

6

DN	Kód produktu	Cena	€ - SK
130	13B50S8V2	734	30,6
140	14B50S8V2	755	31,5
150	15B50S8V2	791	33,0
160	16B50S8V2	827	34,5
170	17B50S8V2	864	36,0
180	18B50S8V2	900	37,5
200	20B50S8V2	973	40,5



Komínová hlavica na sťahovací pásik

6

DN	Kód produktu	Cena	€ - SK
130	13010UNI	496	20,7
140	14010UNI	496	20,7
150	15010UNI	501	20,9
160	16010UNI	506	21,1
170	17010UNI	508	21,2
180	18010UNI	510	21,3
200	20010UNI	519	21,6



Komínová hlavica

6

DN	Kód produktu	Cena	€ - SK
130	13010SU	551	23,0
140	14010SU	535	22,3
150	15010SU	568	23,7
160	16010SU	553	23,0
170	17010SU	589	24,5
180	18010SU	568	23,7
200	20010SU	581	24,2

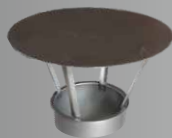

Hlavica meidingerova do keramiky

6

DN	Kód produktu	Cena	€ - SK
130	13010SSU	1 061	44,2
140	14010SSU	1 076	44,8
150	15010SSU	1 091	45,5
160	16010SSU	1 106	46,1
170	17010SSU	1 121	46,7
180	18010SSU	1 136	47,3
200	20010SSU	1 166	48,6



- hlavica do Schiedel keramiky

Kontrolný otvor s prackou

6

DN	Kód produktu	Cena	€ - SK
120	120KOSU	270	11,3
130	130KOSU	272	11,3
140	140KOSU	274	11,4
150	150KOSU	276	11,5
160	160KOSU	278	11,6
180	180KOSU	280	11,7
200	200KOSU	282	11,8



Koncový dilatačný diel

6

DN	Kód produktu	Cena	€ - SK
130	130DDS8V2	638	26,6
140	140DDS8V2	654	27,3
150	150DDS8V2	709	29,5
160	160DDS8V2	751	31,3
170	170DDS8V2	802	33,4
180	180DDS8V2	829	34,5
200	200DDS8V2	916	38,2



AK Spona

3

DN	Kód produktu	Rozměr	Cena	€ - SK
120	21050000120	151 mm	415	19,8
130	21050000130	148 mm	415	19,8
140	21050000140	148 mm	475	19,8
150	21050000150	127 mm	475	19,8
160	21050000160	116 mm	475	19,8
170	21050000170	130 mm	481	20,0
180	21050000180	159 mm	488	20,3
200	21050000200	135 mm	563	23,5
250	21050000250	189 mm	606	25,3
300	21050000300	190 mm	844	35,2

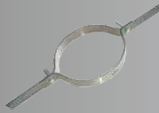

Golier nízky

3

DN	Kód produktu	Cena	€ - SK
130	13013SW	764	31,8
140	14013SW	777	32,4
150	15013SW	795	33,1
160	16013SW	799	33,3
170	17013SW	800	33,3
180	18013SW	802	33,4
200	20013SW	883	36,8
250	25013SW	1 120	46,7
300	30013SW	1 260	52,5



Hlavica s lapačom iskier

6

DN	Kód produktu	Cena	€ - SK
120	12010LJSU	1 257	52,4
130	13010LJSU	1 278	53,3
140	14010LJSU	1 288	53,7
150	15010LJSU	1 310	54,6
160	16010LJSU	1 316	54,8
170	17010LJSU	1 325	55,2
180	18010LJSU	1 330	55,4
200	20010LJSU	1 348	56,2



Krycí plech s otvorom a krčkom 10 cm ③

Do rozmeru	Kód produktu	Cena	€ - SK
500x500	Krycíplech1	1 798	74,9
700x700	Krycíplech2	2 280	95,0
900x900	Krycíplech3	3 228	134,5

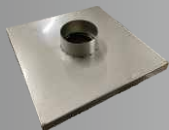

- vr. odkvapového zahnutia
- bez goliera
- ostatné plechy objednávajte ako atyp po dohode s OZ

Ukončovací kryt komína vr. goliera ③

DN	Kód produktu	Cena	€ - SK
130	13852SW	1 209	50,4
140	14852SW	1 230	51,3
150	15852SW	1 296	54,0
160	16852SW	1 379	57,5
180	18852SW	1 462	60,9
200	20852SW	1 672	69,7



Priechodka strechou rovná ③

DN	Kód produktu	Cena	€ - SK
130	13019SW	2 581	107,5
140	14019SW	2 360	98,3
150	15019SW	2 610	108,8
160	16019SW	2 623	109,3
180	18019SW	2 636	109,8
200	20019SW	2 636	109,8



- olovený plát na inštaláciu pod krytinu

Priechodka strechou 30° / 45° vr. goliera ③

DN	Kód produktu	Cena	€ - SK
130	13017SW	3 102	129,3
140	14017SW	2 832	118,0
150	15017SW	3 129	130,4
160	16017SW	3 143	131,0
180	18017SW	3 157	131,5
200	20017SW	3 157	131,5

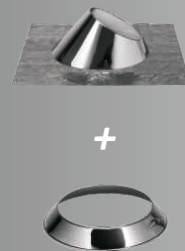

- olovený plát na inštaláciu pod krytinu

Priechodka strechou 5° / 30° vr. goliera ③

DN	Kód produktu	Cena	€ - SK
130	13018SW	3 102	129,3
140	14018SW	2 832	118,0
150	15018SW	3 129	130,4
160	16018SW	3 143	131,0
180	18018SW	3 157	131,5
200	20018SW	3 157	131,5



- olovený plát na inštaláciu pod krytinu

NEREZOVÝ SYSTÉM JEDNODUCHÝ S10

Pevné palivá, suchá prevádzka

Plne kompatibilný so systémom S8V2

EN 1856-2 T600 N1 D Vm L500100 G

Nerezový systém jednoduchý S10		strana
A	komínová hlavica	52
B	predĺženie 950 mm	48
C	t - kus 90°	49
D	čistaci diel s dvierkami	51
E	uzáver s bočným odtokom	50

Uľahčíte si prácu so zostavením a kalkuláciou
komínového systému:

www.ricomgas.sk

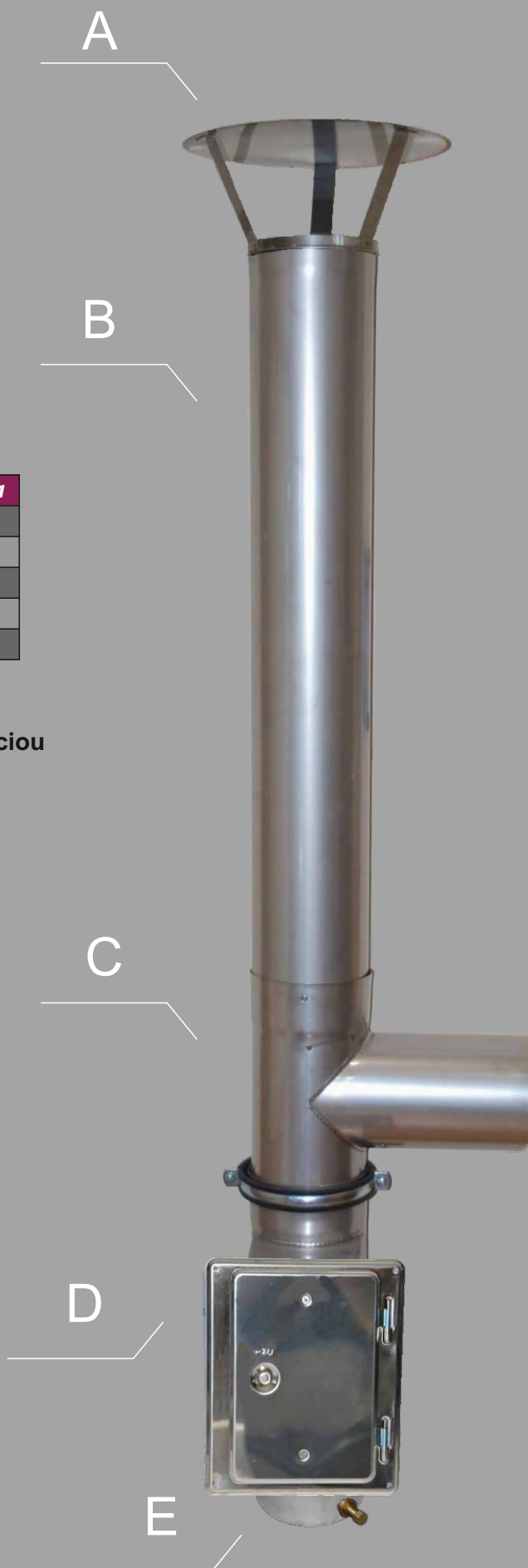

Rúra - 200 mm

6

DN	Kód produktu	Cena	€ - SK
130	13025S10	337	14,0
140	14025S10	361	15,0
150	15025S10	385	16,0
160	16025S10	409	17,0
180	18025S10	457	19,0
200	20025S10	505	21,0

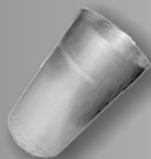

Rúra - 450 mm

6

DN	Kód produktu	Cena	€ - SK
130	13024S10	662	27,6
140	14024S10	709	29,5
150	15024S10	757	31,5
160	16024S10	804	33,5
180	18024S10	901	37,5
200	20024S10	997	41,5



Rúra - 950 mm

6

DN	Kód produktu	Cena	€ - SK
130	13020S10	1 301	54,2
140	14020S10	1 396	58,2
150	15020S10	1 491	62,1
160	16020S10	1 589	66,2
180	18020S10	1 779	74,1
200	20020S10	1 971	82,1



Vsuvka - 450 mm

6

DN	Kód produktu	Cena	€ - SK
130	13VSU24S8V2	532	22,2
140	14VSU24S8V2	572	23,8
150	15VSU24S8V2	611	25,5
160	16VSU24S8V2	649	27,0
170	17VSU24S8V2	688	28,7
180	18VSU24S8V2	726	30,3
200	20VSU24S8V2	804	33,5



Vsuvka - 950 mm

6

DN	Kód produktu	Cena	€ - SK
140	14VSU20S8V2	1 123	46,8
150	15VSU20S8V2	1 199	50,0
150	16VSU20S8V2	1 276	53,2
170	17VSU20S8V2	1 355	56,5
180	18VSU20S8V2	1 431	59,6
200	20VSU20S8V2	1 586	66,1

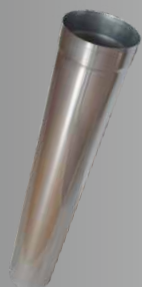

Rúra s očkami na spúšťanie 950 mm

6

DN	Kód produktu	Cena	€ - SK
130	13203S10	1 425	59,4
140	14203S10	1 529	63,7
150	15203S10	1 634	68,1
160	16203S10	1 738	72,4
170	17203S10	1 846	76,9
180	18203S10	1 950	81,3
200	20203S10	2 160	90,0



Rúra pre skúšanie priechodnosti

6

komínového telesa

DN	Kód produktu	Cena	€ - SK
140	14025SUTEST	1 116	46,5
150	15025SUTEST	1 152	48,0
160	16025SUTEST	1 188	49,5
170	17025SUTEST	1 228	51,2
180	18025SUTEST	1 264	52,7
200	20025SUTEST	1 344	56,0



Koleno 15°

6

DN	Kód produktu	Cena	€ - SK
130	13044S10	478	19,9
140	14044S10	500	20,8
150	15044S10	522	21,8
160	16044S10	544	22,7
180	18044S10	603	25,1
200	20044S10	661	27,5



Koleno 30°

6

DN	Kód produktu	Cena	€ - SK
130	13042S10	575	24,0
140	14042S10	603	25,1
150	15042S10	632	26,3
160	16042S10	661	27,5
180	18042S10	719	30,0
200	20042S10	777	32,4



Koleno 45°

6

DN	Kód produktu	Cena	€ - SK
130	13040S10	778	32,4
140	14040S10	816	34,0
150	15040S10	840	35,0
160	16040S10	857	35,7
170	17040S10	893	37,2
180	18040S10	921	38,4
200	20040S10	1 080	45,0



Koleno 90°

6

DN	Kód produktu	Cena	€ - SK
130	13433S10	1 125	46,9
140	14433S10	1 175	49,0
150	15433S10	1 270	52,9
160	16433S10	1 316	54,8
170	17433S10	1 395	58,1
180	18433S10	1 408	58,7
200	20433S10	1 516	63,2



T - kus 45°

6

DN	Kód produktu	Cena	€ - SK
130	13032S10	1 566	65,3
140	14032S10	1 634	68,1
150	15032S10	1 706	71,1
160	16032S10	1 985	82,7
170	17032S10	2 105	87,7
180	18032S10	2 206	91,9
200	20032S10	2 452	102,2



Koleno prestavitelné 0 - 45°

6

DN	Kód produktu	Cena	€ - SK
130	13045S10	1 110	46,3
140	14045S10	1 185	49,4
150	15045S10	1 258	52,4
160	16045S10	1 333	55,5
170	17045S10	1 467	61,1
180	18045S10	1 589	66,2
200	20045S10	1 748	72,8



T - kus 90°

6

DN	Kód produktu	Cena	€ - SK
130	13031S10	1 107	46,1
140	14031S10	1 159	48,3
150	15031S10	1 318	54,9
160	16031S10	1 386	57,8
170	17031S10	1 459	60,8
180	18031S10	1 538	64,1
200	20031S10	1 752	73,0



Koleno prestavitelné 0 - 90°

6

DN	Kód produktu	Cena	€ - SK
130	13041S10	1 498	62,4
140	14041S10	1 597	66,5
150	15041S10	1 719	71,6
160	16041S10	1 759	73,3
170	17041S10	1 864	77,7
180	18041S10	1 949	81,2
200	20041S10	2 460	102,5



T - kus s bajonetom - 1,0 mm

6

DN	Kód produktu	Cena	€ - SK
130	13031S10BAJ	1 405	58,5
140	14031S10BAJ	1 417	59,0
150	15031S10BAJ	1 678	69,9
160	16031S10BAJ	1 739	72,5
170	17031S10BAJ	1 786	74,4
180	18031S10BAJ	1 863	77,6
200	20031S10BAJ	1 986	82,8



Koleno prestavitelné 0 - 90° s kontrolným otvorom

6

DN	Kód produktu	Cena	€ - SK
130	13041S10KO	2 303	96,0
140	14041S10KO	2 433	101,4
150	15041S10KO	2 454	102,3
160	16041S10KO	2 464	102,7
170	17041S10KO	2 699	112,5
180	18041S10KO	2 754	114,8
200	20041S10KO	3 165	131,9



T-Kus 90° - hrdlo pre flex 0,4 mm

6

DN	Kód produktu	Cena	€ - SK
130	13F31S10	1 107	46,1
140	14F31S10	1 159	48,3
150	15F31S10	1 333	55,5
160	16F31S10	1 386	57,8
170	17F31S10	1 474	61,4
180	18F31S10	1 560	65,0



Koleno 90° s kontrolným otvorom

6

DN	Kód produktu	Cena	€ - SK
130	13432S10	1 235	51,5
140	14432S10	1 330	55,4
150	15432S10	1 425	59,4
160	16432S10	1 671	69,6
170	17432S10	1 691	70,5
180	18432S10	1 710	71,3
200	20432S10	1 900	79,2



Redukovaný T-kus 90° s odbočkou S10

6

DN	Kód produktu	Cena	€ - SK
150/130	15013031S10	1 438	59,9
160/150	16015031S10	1 543	64,3
170/150	17015031S10	1 556	64,8
170/160	17016031S10	1 610	67,1
180/150	18015031S10	1 610	67,1
180/160	18016031S10	1 653	68,9
200/150	20015031S10	1 675	69,8
200/160	20016031S10	1 697	70,7
200/180	20018031S10	1 538	64,1



Bajonetový redukovaný T-kus

6

DN	Kód produktu	Cena	€ - SK
140/130	14013031S10BAJ	1 855	77,3
150/130	15013031S10BAJ	1 881	78,4
150/140	15014031S10BAJ	1 906	79,4
160/130	16013031S10BAJ	1 924	80,2
160/140	16014031S10BAJ	1 938	80,8
160/150	16015031S10BAJ	1 954	81,4
170/130	17013031S10BAJ	1 966	81,9
170/140	17014031S10BAJ	1 976	82,3
170/150	17015031S10BAJ	1 988	82,8
170/160	17016031S10BAJ	1 998	83,3
180/130	18013031S10BAJ	2 011	83,8
180/140	18014031S10BAJ	2 023	84,3
180/150	18015031S10BAJ	2 034	84,8
180/160	18016031S10BAJ	2 045	85,2
180/170	18017031S10BAJ	2 057	85,7
200/130	20013031S10BAJ	2 107	87,8
200/140	20014031S10BAJ	2 139	89,1
200/150	20015031S10BAJ	2 171	90,5
200/160	20016031S10BAJ	2 238	93,3
200/170	20017031S10BAJ	2 237	93,2
200/180	20018031S10BAJ	2 284	95,2



T-kus 90° s prevlečnou odbočkou

6

DN	Kód produktu	Cena	€ - SK
120	12035S10	1 211	50,5
130	13035S10	1 275	53,1
140	14035S10	1 327	55,3
150	15035S10	1 486	61,9
160	16035S10	1 554	64,8
170	17035S10	1 627	67,8
180	18035S10	1 706	71,1
200	20035S10	1 920	80,0



- dĺžka odbočky 245 mm
- výška T-kusu 280 mm
- presuná odbočka vo veľkosti hrdla

Adapter ťahaný

6

DN	Kód produktu	Cena	€ - SK
130/140	28130140SU	192	8,0
130/150	28130150SU	192	8,0
130/160	28130160SU	352	14,7
140/150	28140150SU	205	8,5
140/160	28140160SU	205	8,5
150/160	28150160SU	219	9,1
150/180	28150180SU	229	9,5
160/180	28160180SU	250	10,4
170/180	28170180SU	193	8,0
180/200	28180200SU	260	10,8



Adapter varený

6

DN	Kód produktu	Cena	€ - SK
130/150	30130150SU	672	28,0
130/160	30130160SU	684	28,5
130/180	30130180SU	710	29,6
130/200	30130200SU	735	30,6
140/160	30140160SU	618	25,8
140/180	30140180SU	638	26,6
140/200	30140200SU	699	29,1
150/180	30150180SU	739	30,8
150/200	30150200SU	798	33,3
150/250	30150250SU	679	28,3
160/200	30160200SU	627	26,1
180/250	30180250SU	677	28,2



Spojka nerezových rúr (cípant)

6

DN	Kód produktu	Cena	€ - SK
80	C080	554	23,1
130	C130	602	25,1
150	C150	619	25,8
160	C160	661	27,5
170	C170	685	28,5
180	C180	704	29,3
200	C200	720	30,0



Uzáver s bočným odtokom

6

DN	Kód produktu	Cena	€ - SK
130	13061S10	436	18,2
140	14061S10	445	18,5
150	15061S10	484	20,2
160	16061S10	493	20,5
170	17061S10	502	20,9
180	18061S10	512	21,3
200	20061S10	545	22,7



Uzáver so spodným odtokom

6

DN	Kód produktu	Cena	€ - SK
130	13061SS10	693	28,9
140	14061SS10	698	29,1
150	15061SS10	705	29,4
160	16061SS10	724	30,2
170	17061SS10	729	30,4
180	18061SS10	735	30,6
200	20061SS10	801	33,4



Uzáver

6

DN	Kód produktu	Cena	€ - SK
130	13060S10	293	12,2
140	14060S10	317	13,2
150	15060S10	348	14,5
160	16060S10	353	14,7
170	17060S10	369	15,4
180	18060S10	383	16,0
200	20060S10	431	18,0



Komínové viečko (6)

DN	Kód produktu	Cena	€ - SK
130	13063S10	293	12,2
140	14063S10	330	13,8
150	15063S10	335	14,0
160	16063S10	362	15,1
170	17063S10	368	15,3
180	18063S10	379	15,8
200	20063S10	424	17,7



Čistiaci diel bez dvierok (6)

DN	Kód produktu	Cena	€ - SK
130	13520S10	1 156	48,2
140	14520S10	1 201	50,0
150	15520S10	1 298	54,1
160	16520S10	1 353	56,4
170	17520S10	1 391	58,0
180	18520S10	1 425	59,4
200	20520S10	1 431	59,6

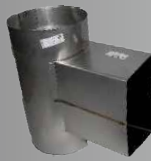

Predĺženie čistiaceho dielu s dvierkami - nerez (19)

DN	Kód produktu	Cena	€ - SK
	TUBDRN20	2 064	86,0
	TUBDRN40	2 459	102,5
	TUBDRN50	2 769	115,4

- dĺžky tubusov predĺženia
 TUBDRNS8V2-20 = 20 cm
 -40 = 40 cm
 -50 = 50 cm.



Predĺženie čistiaceho dielu s dvierkami - biele (6)

DN	Kód produktu	Cena	€ - SK
	TUBDRZNB20	2 211	92,1
	TUBDRZNB40	2 606	108,6
	TUBDRZNB50	2 916	121,5

- dĺžky tubusov predĺženia
 TUBDRNS8V2-20 = 20 cm
 -40 = 40 cm
 -50 = 50 cm.



Predĺženie čistiaceho dielu s dvierkami (6)

s dvierkovým regulátorom ťahu - L = 200mm

DN	Kód produktu	Cena	€ - SK
	TUBDRN20REG	4 236	176,5



Komínové dvierka nerez, pozink, biele (6)

	Kód produktu	Cena	€ - SK
nerez	DRN1420S10	1 623	67,6
pozink	DRZN1420	1 309	54,5
biele	DRZNB1420	1 777	74,0



Náhradné tesnenie do komínových dvierok (6)

DN	Kód produktu	Cena	€ - SK
UNI	TDU	196	8,2

- sada obsahuje šróby



Komínová hlavica na sťahovací pásik (6)

DN	Kód produktu	Cena	€ - SK
130	13010UNI	496	20,7
140	14010UNI	496	20,7
150	15010UNI	501	20,9
160	16010UNI	506	21,1
170	17010UNI	508	21,2
180	18010UNI	510	21,3
200	20010UNI	519	21,6

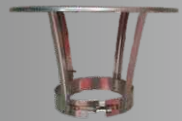

Koncový dilatačný diel (6)

DN	Kód produktu	Cena	€ - SK
130	130DDS10	739	30,8
140	140DDS10	792	33,0
150	150DDS10	849	35,4
160	160DDS10	901	37,5
170	170DDS10	945	39,4
180	180DDS10	997	41,5
200	200DDS10	1 105	46,0



Komínová hlavica (6)

DN	Kód produktu	Cena	€ - SK
130	13010SU	551	23,0
140	14010SU	535	22,3
150	15010SU	568	23,7
160	16010SU	553	23,0
170	17010SU	589	24,5
180	18010SU	568	23,7
200	20010SU	581	24,2

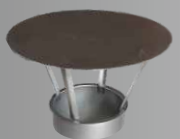

Hlavica meidingerova do keramiky ⑥

DN	Kód produktu	Cena	€ - SK
130	13010SSU	1 061	44,2
140	14010SSU	1 076	44,8
150	15010SSU	1 091	45,5
160	16010SSU	1 106	46,1
170	17010SSU	1 121	46,7
180	18010SSU	1 136	47,3
200	20010SSU	1 166	48,6



- hlavica do Schiedel keramiky

Hlavica ozdobná - OROL ③

DN	Kód produktu	Cena	€ - SK
130	13010ORL	2 825	117,7
150	15010ORL	3 458	144,1
160	16010ORL	3 960	165,0
180	18010ORL	3 990	166,3
200	20010ORL	4 632	193,0
250	25010ORL	5 023	209,3



AK Spona ③

DN	Kód produktu	Rozměr	Cena	€ - SK
120	21050000120	151 mm	415	19,8
130	21050000130	148 mm	415	19,8
140	21050000140	148 mm	475	19,8
150	21050000150	127 mm	475	19,8
160	21050000160	116 mm	475	19,8
170	21050000170	130 mm	481	20,0
180	21050000180	159 mm	488	20,3
200	21050000200	135 mm	563	23,5
250	21050000250	189 mm	606	25,3
300	21050000300	190 mm	844	35,2



Golier nízky ③

DN	Kód produktu	Cena	€ - SK
130	13013SW	764	31,8
140	14013SW	777	32,4
150	15013SW	795	33,1
160	16013SW	799	33,3
170	17013SW	800	33,3
180	18013SW	802	33,4
200	20013SW	883	36,8
250	25013SW	1 120	46,7
300	30013SW	1 260	52,5



Čistiaci prvok ⑥

DN	Kód produktu	Cena	€ - SK
130	13050S10	755	31,5
140	14050S10	808	33,7
150	15050S10	853	35,5
160	16050S10	927	38,6
170	17050S10	943	39,3
180	18050S10	988	41,2
200	20050S10	1 078	44,9



Čistiaci prvok s pružinkou ⑥

DN	Kód produktu	Cena	€ - SK
130	13B50S10	929	38,7
140	14B50S10	950	39,6
150	15B50S10	986	41,1
160	16B50S10	1 026	42,8
170	17B50S10	1 059	44,1
180	18B50S10	1 089	45,4
200	20B50S10	1 169	48,7



Kontrolný otvor s prackou ⑥

DN	Kód produktu	Cena	€ - SK
120	120KOSU	270	11,3
130	130KOSU	272	11,3
140	140KOSU	274	11,4
150	150KOSU	276	11,5
160	160KOSU	278	11,6
180	180KOSU	280	11,7
200	200KOSU	282	11,8



Hlavica s lapačom iskier ⑥

DN	Kód produktu	Cena	€ - SK
120	12010LJSU	1 257	52,4
130	13010LJSU	1 278	53,3
140	14010LJSU	1 288	53,7
150	15010LJSU	1 310	54,6
160	16010LJSU	1 316	54,8
170	17010LJSU	1 325	55,2
180	18010LJSU	1 330	55,4
200	20010LJSU	1 348	56,2



Ukončovaci kryt komína vr. goliera ③

DN	Kód produktu	Cena	€ - SK
130	13852SW	1 209	50,4
140	14852SW	1 230	51,3
150	15852SW	1 296	54,0
160	16852SW	1 379	57,5
180	18852SW	1 462	60,9
200	20852SW	1 672	69,7

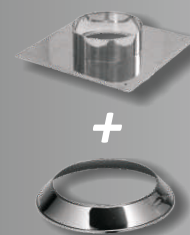

Priechodka strechou 30° / 45° vr. goliera ③

DN	Kód produktu	Cena	€ - SK
130	13017SW	3 102	129,3
140	14017SW	2 832	118,0
150	15017SW	3 129	130,4
160	16017SW	3 143	131,0
180	18017SW	3 157	131,5
200	20017SW	3 157	131,5



Priechodka strechou 5° / 30° vr. goliera

③

DN	Kód produktu	Cena	€ - SK
130	13018SW	3 102	129,3
140	14018SW	2 832	118,0
150	15018SW	3 129	130,4
160	16018SW	3 143	131,0
180	18018SW	3 157	131,5
200	20018SW	3 157	131,5

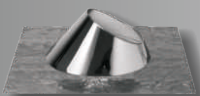

+



Priechodka strechou rovná

③

DN	Kód produktu	Cena	€ - SK
130	13019SW	2 581	107,5
140	14019SW	2 360	98,3
150	15019SW	2 610	108,8
160	16019SW	2 623	109,3
180	18019SW	2 636	109,8
200	20019SW	2 636	109,8



+



Oválna rúra - 250 mm

6

DN	Kód produktu	Cena	€ - SK
130	13025OVL8/149x118	358	14,9
140	14025OVL8/164x128	385	16,0
150	15025OVL8/182x123	410	17,1
150	15025OVL8/188x118	410	17,1
160	16025OVL8/195x130	435	18,1
170	17025OVL8/213x133	462	19,3
180	18025OVL8/220x150	573	23,9



Oválna rúra - 450 mm

6

DN	Kód produktu	Cena	€ - SK
130	13024OVL8/149x118	699	29,1
140	14024OVL8/164x128	753	31,4
150	15024OVL8/182x123	804	33,5
150	15024OVL8/188x118	804	33,5
160	16024OVL8/195x130	854	35,6
170	17024OVL8/213x133	905	37,7
180	18024OVL8/220x150	1 130	47,1
200	20024OVL8/136x279	1 406	58,6



Oválna rúra - 950 mm

6

DN	Kód produktu	Cena	€ - SK
130	13020OVL8/149x118	1 370	57,1
140	14020OVL8/164x128	1 478	61,6
150	15020OVL8/182x123	1 578	65,8
150	15020OVL8/188x118	1 578	65,8
160	16020OVL8/195x130	1 679	70,0
170	17020OVL8/213x133	1 783	74,3
180	18020OVL8/220x150	2 242	93,4
200	20020OVL8/136x279	2 805	116,9



T - kus

6

DN	Kód produktu	Cena	€ - SK
130	13B31OVL8/149x118	1 270	52,9
140	14B31OVL8/164x128	1 346	56,1
150	15B31OVL8/182x123	1 426	59,4
150	15B31OVL8/188x118	1 426	59,4
160	16B31OVL8/195x130	1 498	62,4
170	17B31OVL8/213x133	1 580	65,8
180	18B31OVL8/220x150	1 847	77,0
200	20B31OVL8/136x279	2 196	91,5



Uzáver

6

DN	Kód produktu	Cena	€ - SK
130	13060OVL8/149x118	343	14,3
140	14060OVL8/164x128	370	15,4
150	15060OVL8/182x123	413	17,2
150	15060OVL8/188x118	413	17,2
160	16060OVL8/195x130	435	18,1
170	17060OVL8/213x133	430	17,9
180	18060OVL8/220x150	478	19,9
200	20060OVL8/136x279	521	21,7



Uzáver s bočným odtokom

6

DN	Kód produktu	Cena	€ - SK
130	13061OVL8/149x118	499	20,8
140	14061OVL8/164x128	544	22,7
150	15061OVL8/182x123	543	22,6
150	15061OVL8/188x118	543	22,6
160	16061OVL8/195x130	569	23,7
170	17061OVL8/213x133	578	24,1
180	18061OVL8/220x150	624	26,0
200	20061OVL8/136x279	679	28,3



Čistiaci prvok

6

DN	Kód produktu	Cena	€ - SK
130	13050OVL8/149x118	816	34,0
140	14050OVL8/164x128	868	36,2
150	15050OVL8/182x123	915	38,1
150	15050OVL8/188x118	915	38,1
160	16050OVL8/195x130	963	40,1
170	17050OVL8/213x133	1 012	42,2
180	18050OVL8/220x150	1 059	44,1



Čistiaci diel bez dvierok

6

DN	Kód produktu	Cena	€ - SK
130	13520OVL8/149x118	1 425	59,4
140	14520OVL8/164x128	1 474	61,4
150	15520OVL8/182x123	1 554	64,8
150	15520OVL8/188x118	1 554	64,8
160	16520OVL8/195x130	1 653	68,9
170	17520OVL8/213x133	1 742	72,6
180	18520OVL8/220x150	1 832	76,3
200	20520OVL8/136x279	2 011	83,8



Predĺženie čistiaceho dielu s dvierkami - nerez

6

DN	Kód produktu	Cena	€ - SK
	TUBDRN20	2 064	86,0
	TUBDRN40	2 459	102,5
	TUBDRN50	2 769	115,4



- dĺžky tubusov predĺženia
 TUBDRNS8V2-20 = 20 cm
 -40 = 40 cm
 -50 = 50 cm.

Predĺženie čistiaceho dielu s dvierkami - biele

6

DN	Kód produktu	Cena	€ - SK
	TUBDRZNB20	2 211	92,1
	TUBDRZNB40	2 606	108,6
	TUBDRZNB50	2 916	121,5



Hlavica

6

DN	Kód produktu	Cena	€ - SK
130	13010OVL/149x118	725	30,2
140	14010OVL/164x128	704	29,3
150	15010OVL/182x123	746	31,1
150	15010OVL/188x118	746	31,1
160	16010OVL/195x130	728	30,3
170	17010OVL/213x133	775	32,3
180	18010OVL/220x150	747	31,1
200	20010OVL/136x279	766	31,9

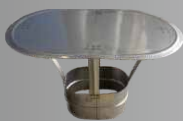

Oválna komínová hlavica na ťahovací pásik

6

DN	Kód produktu	Cena	€ - SK
130	13010UNIOVL/149x118	745	31,0
140	14010UNIOVL/120x160	724	30,2
150	15010UNIOVL/110x185	766	31,9
150	15010UNIOVL/120x175	766	31,9
160	16010UNIOVL/120x195	748	31,2
170	17010UNIOVL/130x205	795	33,1
180	18010UNIOVL/130x220	767	32,0



AK spona

6

DN	Kód produktu	Cena	€ - SK
130	AKSPONAOVL/149x118	890	37,1
140	AKSPONAOVL/164x128	890	37,1
150	AKSPONAOVL/182x123	890	37,1
150	AKSPONAOVL/188x118	890	37,1
160	AKSPONAOVL/195x130	890	37,1
170	AKSPONAOVL/213x133	890	37,1
180	AKSPONAOVL/220x150	890	37,1



Ukončovaci kryt komína

6

DN	Kód produktu	Cena	€ - SK
130	13852OVL/149x118	980	40,8
140	14852OVL/164x128	980	40,8
150	15852OVL/182x123	980	40,8
150	15852OVL/188x118	980	40,8
160	16852OVL/195x130	980	40,8
170	17852OVL/213x133	980	40,8
180	18852OVL/220x150	980	40,8

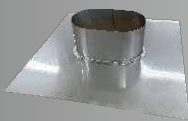

Golier

6

DN	Kód produktu	Cena	€ - SK
130	13013OVL/149x118	764	31,8
140	14013OVL/164x128	777	32,4
150	15013OVL/182x123	795	33,1
150	15013OVL/188x118	795	33,1
160	16013OVL/195x130	799	33,3
170	17013OVL/213x133	816	34,0
180	18013OVL/220x150	829	34,5
200	20013OVL/136x279	859	35,8



Adaptér z rúry na ovál

6

DN	Kód produktu	Cena	€ - SK
130	28130OVL8/149x118	448	18,7
140	28140OVL8/164x128	482	20,1
150	28150OVL8/188x118	513	21,4
150	28150OVL8/182x123	513	21,4
160	28160OVL8/195x130	544	22,7
170	28170OVL8/213x133	578	24,1
180	28180OVL8/220x150	717	29,9



Adaptér z oválu na rúru

6

DN	Kód produktu	Cena	€ - SK
130	27130OVL8/149x118	448	18,7
140	27140OVL8/164x128	482	20,1
150	27150OVL8/188x118	513	21,4
150	27150OVL8/182x123	513	21,4
160	27160OVL8/195x130	544	22,7
170	27170OVL8/213x133	578	24,1
180	27180OVL8/220x150	717	29,9



Oválna rúra - 250 mm

6

DN	Kód produktu	Cena	€ - SK
130	13025OVL1/149x118	459	19,1
140	14025OVL1/164x128	491	20,5
150	15025OVL1/182x123	524	21,8
150	15025OVL1/188x118	524	21,8
160	16025OVL1/195x130	556	23,2
170	17025OVL1/213x133	590	24,6
180	18025OVL1/220x150	678	28,3



Oválna rúra - 450 mm

6

DN	Kód produktu	Cena	€ - SK
130	13024OVL1/149x118	901	37,5
140	14024OVL1/164x128	966	40,3
150	15024OVL1/182x123	1 033	43,0
150	15024OVL1/188x118	1 033	43,0
160	16024OVL1/195x130	1 098	45,8
170	17024OVL1/213x133	1 165	48,5
180	18024OVL1/220x150	1 343	56,0



Oválna rúra - 950 mm

6

DN	Kód produktu	Cena	€ - SK
130	13020OVL1/149x118	1 781	74,2
140	14020OVL1/164x128	1 911	79,6
150	15020OVL1/182x123	2 043	85,1
150	15020OVL1/188x118	2 043	85,1
160	16020OVL1/195x130	2 173	90,5
170	17020OVL1/213x133	2 308	96,2
180	18020OVL1/220x150	2 667	111,1



T - kus

6

DN	Kód produktu	Cena	€ - SK
130	13B31OVL1/149x118	1 503	62,6
140	14B31OVL1/164x128	1 561	65,0
150	15B31OVL1/182x123	1 778	74,1
150	15B31OVL1/188x118	1 778	74,1
160	16B31OVL1/195x130	1 873	78,0
170	17B31OVL1/213x133	1 973	82,2
180	18B31OVL1/220x150	2 065	86,0



Uzáver

6

DN	Kód produktu	Cena	€ - SK
130	13060OVL1/149x118	366	15,3
140	14060OVL1/164x128	396	16,5
150	15060OVL1/182x123	435	18,1
150	15060OVL1/188x118	435	18,1
160	16060OVL1/195x130	441	18,4
170	17060OVL1/213x133	462	19,3
180	18060OVL1/220x150	479	20,0



Uzáver s bočným odtokom

6

DN	Kód produktu	Cena	€ - SK
130	13061OVL1/149x118	545	22,7
140	14061OVL1/164x128	557	23,2
150	15061OVL1/182x123	605	25,2
150	15061OVL1/188x118	605	25,2
160	16061OVL1/195x130	616	25,7
170	17061OVL1/213x133	628	26,2
180	18061OVL1/220x150	640	26,7



Čistiaci prvok

6

DN	Kód produktu	Cena	€ - SK
130	13050OVL1/149x118	1 031	43,0
140	14050OVL1/164x128	1 095	45,6
150	15050OVL1/182x123	1 158	48,3
150	15050OVL1/188x118	1 158	48,3
160	16050OVL1/195x130	1 270	52,9
170	17050OVL1/213x133	1 287	53,6
180	18050OVL1/220x150	1 350	56,3



Čistiaci diel bez dvierok

6

DN	Kód produktu	Cena	€ - SK
130	13520OVL1/149x118	1 586	66,1
140	14520OVL1/164x128	1 645	68,5
150	15520OVL1/182x123	1 773	73,9
150	15520OVL1/188x118	1 773	73,9
160	16520OVL1/195x130	1 954	81,4
170	17520OVL1/213x133	1 892	78,8
180	18520OVL1/220x150	1 837	76,5



Predženie čistiaceho dielu s dvierkami - nerez

6

DN	Kód produktu	Cena	€ - SK
	TUBDRN20	2 064	86,0
	TUBDRN40	2 459	102,5
	TUBDRN50	2 769	115,4



- dĺžky tubusov predženia
TUBDRNS8V2-20 = 20 cm
-40 = 40 cm
-50 = 50 cm.

Predženie čistiaceho dielu s dvierkami - biele

6

DN	Kód produktu	Cena	€ - SK
	TUBDRZNB20	2 211	92,1
	TUBDRZNB40	2 606	108,6
	TUBDRZNB50	2 916	121,5



- dĺžky tubusov predženia
TUBDRNS8V2-20 = 20 cm
-40 = 40 cm
-50 = 50 cm.

Hlavica

6

DN	Kód produktu	Cena	€ - SK
130	13010OVL/149x118	725	30,2
140	14010OVL/164x128	704	29,3
150	15010OVL/182x123	746	31,1
150	15010OVL/188x118	746	31,1
160	16010OVL/195x130	728	30,3
170	17010OVL/213x133	775	32,3
180	18010OVL/220x150	747	31,1



Oválná komínová hlavice na stahovací pásek

6

DN	Kód produktu	Cena	€ - SK
130	13010UNIOVL/149x118	745	31,0
140	14010UNIOVL/120x160	724	30,2
150	15010UNIOVL/110x185	766	31,9
150	15010UNIOVL/120x175	766	31,9
160	16010UNIOVL/120x195	748	31,2
170	17010UNIOVL/130x205	795	33,1
180	18010UNIOVL/130x220	767	32,0



AK spona

6

DN	Kód produktu	Cena	€ - SK
130	AKSPONAOVL/149x118	890	37,1
140	AKSPONAOVL/164x128	890	37,1
150	AKSPONAOVL/182x123	890	37,1
150	AKSPONAOVL/188x118	890	37,1
160	AKSPONAOVL/195x130	890	37,1
170	AKSPONAOVL/213x133	890	37,1
180	AKSPONAOVL/220x150	890	37,1



Ukončovací kryt komína

6

DN	Kód produktu	Cena	€ - SK
130	13852OVL/149x118	980	40,8
140	14852OVL/164x128	980	40,8
150	15852OVL/182x123	980	40,8
150	15852OVL/188x118	980	40,8
160	16852OVL/195x130	980	40,8
170	17852OVL/213x133	980	40,8
180	18852OVL/220x150	980	40,8

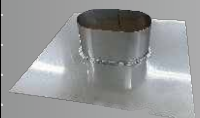

Golier

6

DN	Kód produktu	Cena	€ - SK
130	13013OVL/149x118	764	31,8
140	14013OVL/164x128	777	32,4
150	15013OVL/182x123	795	33,1
150	15013OVL/188x118	795	33,1
160	16013OVL/195x130	799	33,3
170	17013OVL/213x133	816	34,0
180	18013OVL/220x150	829	34,5
200	20013OVL/136x279	859	35,8



Adaptér z rúry na ovál

6

DN	Kód produktu	Cena	€ - SK
130	28130OVL1/149x118	574	23,9
140	28140OVL1/164x128	614	25,6
150	28150OVL1/188x118	655	27,3
150	28150OVL1/182x123	655	27,3
160	28160OVL1/195x130	695	29,0
170	28170OVL1/213x133	738	30,8
180	28180OVL1/220x150	848	35,3



Adaptér z oválu na rúru

6

DN	Kód produktu	Cena	€ - SK
130	27130OVL1/149x118	574	23,9
140	27140OVL1/164x128	614	25,6
150	27150OVL1/188x118	655	27,3
150	27150OVL1/182x123	655	27,3
160	27160OVL1/195x130	695	29,0
170	27170OVL1/213x133	738	30,8
180	27180OVL1/220x150	848	35,3



NEREZOVÝ SYSTÉM TROJZLOŽKOVÝ B10

ricom
gas

Pevné palivá, suchá prevádzka

EN 1856-1 T400 N1 D Vm L500100 G100

Nerezový systém trojzložkový B10		strana
A	komínová hlavica	60
B	ukončenie komína kónické	59
C	predĺženie 950 mm	59
D	ť - kus 90°	59
E	čistiaci diel s dvierkami	59
F	konzola	60

Uľahčíte si prácu so zostavením a kalkuláciou
komínového systému:

www.ricomgas.sk

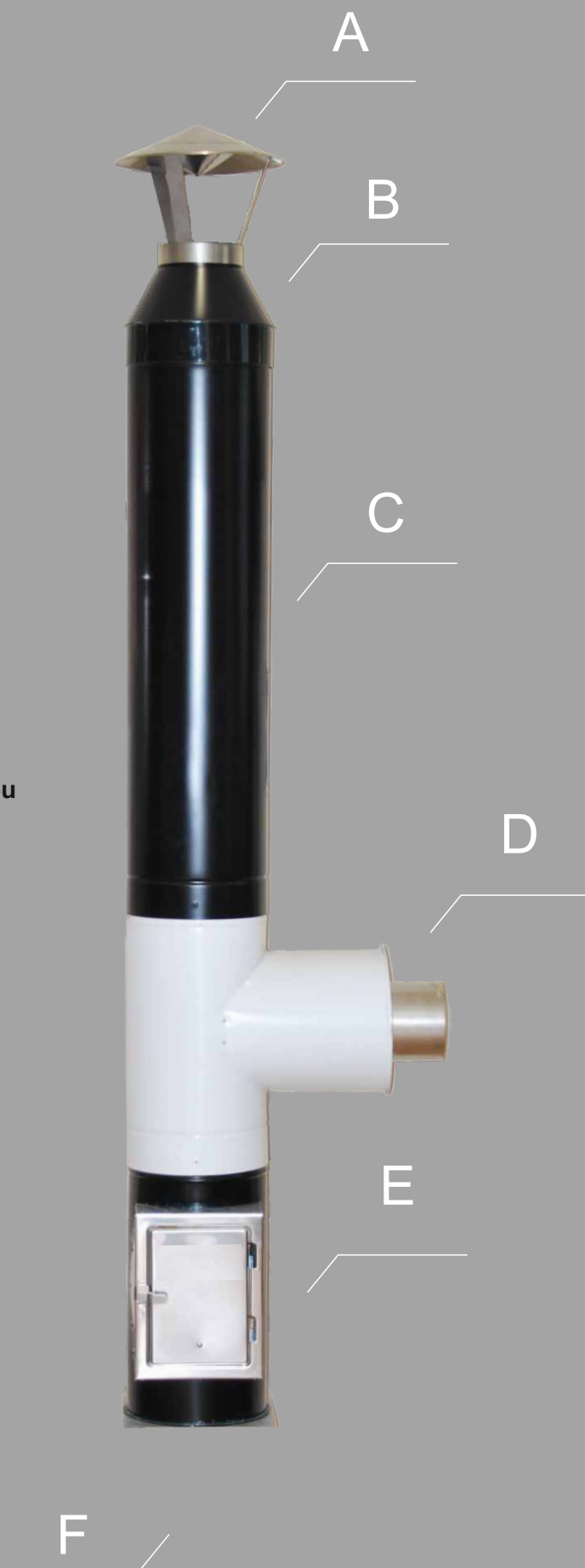

Rúra - 450 mm

⑥

DN	Kód produktu	Cena	€ - SK
130	13024B10	1 434	59,8
140	14024B10	1 501	62,5
150	15024B10	1 564	65,2
160	16024B10	1 555	64,8
180	18024B10	1 956	81,5
200	20024B10	2 031	84,6
250	25024B10	2 732	113,8



T- kus 90°

⑥

DN	Kód produktu	Cena	€ - SK
130	13031B10	2 909	121,2
140	14031B10	3 045	126,9
150	15031B10	3 184	132,7
160	16031B10	3 509	146,2
180	18031B10	3 834	159,8
200	20031B10	4 158	173,3
250	25031B10	5 507	229,5



Rúra - 450 mm

⑥

DN	Kód produktu	Cena	€ - SK
130	13020B10	2 492	103,8
140	14020B10	2 606	108,6
150	15020B10	2 719	113,3
160	16020B10	2 983	124,3
180	18020B10	3 256	135,7
200	20020B10	3 527	147,0
250	25020B10	4 552	189,7



Čistiaci a revízny diel s dvierkami

⑥

DN	Kód produktu	Cena	€ - SK
130	13021B10	4 307	179,5
140	14021B10	4 374	182,3
150	15021B10	4 438	184,9
160	16021B10	4 663	194,3
180	18021B10	4 827	201,1
200	20021B10	4 990	207,9
250	25021B10	6 023	251,0



Koleno 30°

⑥

DN	Kód produktu	Cena	€ - SK
130	13042B10	1 494	62,3
140	14042B10	1 886	78,6
150	15042B10	2 116	88,2
160	16042B10	2 415	100,6
180	18042B10	3 133	130,5
200	20042B10	3 795	158,1
250	25042B10	4 246	176,9



Priechodka strechou 25° / 45° vr. goliera

⑥

DN	Kód produktu	Cena	€ - SK
130	13017B10	2 064	86,0
140	14017B10	2 240	93,3
150	15017B10	2 303	96,0
160	16017B10	1 973	82,2
180	18017B10	2 728	113,7
200	20017B10	2 869	119,5
250	25017B10	3 054	127,3

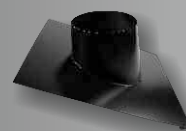

Koleno 45°

⑥

DN	Kód produktu	Cena	€ - SK
130	13040B10	1 494	62,3
140	14040B10	1 886	78,6
150	15040B10	2 116	88,2
160	16040B10	2 415	100,6
180	18040B10	3 133	130,5
200	20040B10	3 795	158,1
250	25040B10	4 246	176,9



Spodné ukončenie rovné - uzáver

⑥

DN	Kód	Cena	€ - SK
130	13060B10	699	29,1
140	14060B10	737	30,7
150	15060B10	787	32,8
160	16060B10	887	37,0
180	18060B10	999	41,6
200	20060B10	1 094	45,6
250	25060B10	1 467	61,1



Koleno 90°

⑥

DN	Kód produktu	Cena	€ - SK
130	13043B10	2 064	86,0
140	14043B10	2 827	117,8
150	15043B10	3 172	132,2
160	16043B10	3 618	150,8
180	18043B10	4 801	200,0
200	20043B10	5 397	224,9
250	25043B10	6 382	265,9

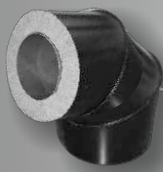

Ukončenie komína kónické

⑥

DN	Kód	Cena	€ - SK
130	13011B10	2 547	106,1
140	14011B10	2 576	107,3
150	15011B10	2 625	109,4
160	16011B10	2 754	114,8
180	18011B10	2 957	123,2
200	20011B10	3 068	127,8
250	25011B10	3 799	158,3



- umožňuje montáž hlavice

Horné zaslepenie dvojité

16

DN	Kód	Cena	€ - SK
130	13012B10	1 445	60,2
140	14012B10	1 516	63,2
150	15012B10	1 531	63,8
160	16012B10	1 558	64,9
180	18012B10	1 612	67,2
200	20012B10	1 704	71,0
250	25012B10	2 323	96,8



- umožňuje výlučne montáž UNIHLAVICE

Dolné zaslepenie (záslepka izolácie)

16

DN	Kód	Cena	€ - SK
130	13063B10	484	20,2
140	14063B10	511	21,3
150	15063B10	552	23,0
160	16063B10	572	23,8
180	18063B10	651	27,1
200	20063B10	741	30,9
250	25063B10	816	34,0



Hlavica s rozrážáčom

16

DN	Kód produktu	Cena	€ - SK
130	13010B10	1 341	55,9
140	14010B10	1 423	59,3
150	15010B10	1 457	60,7
160	16010B10	1 569	65,4
180	18010B10	1 793	74,7
200	20010B10	2 018	84,1
250	25010B10	2 964	123,5



Komínová hlavica na sťahovací pásik

6

DN	Kód produktu	Cena	€ - SK
140	14010UNI	522	21,8
150	15010UNI	527	22,0
160	16010UNI	532	22,2
180	18010UNI	536	22,3
200	20010UNI	546	22,8

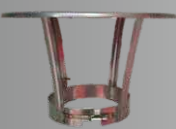

Kotviaca objímka nastaviteľná 20 - 50 cm

16

DN	Kód produktu	Cena	€ - SK
130	13084B10	1 225	51,0
140	14084B10	1 232	51,3
150	15084B10	1 247	52,0
160	16084B10	1 253	52,2
180	18084B10	1 260	52,5
200	20084B10	1 265	52,7
250	25084B10	1 309	54,5

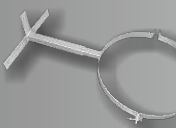

Kotviaca objímka nastaviteľná 0 - 20 cm

16

DN	Kód produktu	Cena	€ - SK
130	13083B10	1 027	42,8
140	14083B10	1 032	43,0
150	15083B10	1 038	43,3
160	16083B10	1 051	43,8
180	18083B10	1 060	44,2
200	20083B10	1 071	44,6
250	25083B10	1 098	45,8

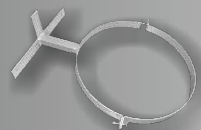

Konzola nosná 0 - 20 cm

16

DN	Kód produktu	Cena	€ - SK
130	13057B10	1 146	47,8
140	14057B10	1 190	49,6
150	15057B10	1 247	52,0
160	16057B10	1 265	52,7
180	18057B10	1 281	53,4
200	20057B10	1 309	54,5
250	25057B10	1 342	55,9

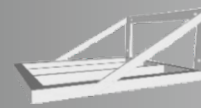

Konzola nosná 20 - 50 cm

16

DN	Kód produktu	Cena	€ - SK
130	13058B10	1 479	61,6
140	14058B10	1 511	63,0
150	15058B10	1 538	64,1
160	16058B10	1 569	65,4
180	18058B10	1 600	66,7
200	20058B10	1 630	67,9
250	25058B10	1 660	69,2



Kroková objímka

3

DN	Kód produktu	Cena	€ - SK
130	KO190	2 265	94,4
150	KO210	2 265	94,4
160	KO220	2 269	94,5
180	KO240	2 273	94,7
200	KO260	2 273	94,7



Vynášací diel - nádstavec komína

16

DN	Kód produktu	Cena	€ - SK
130	13671B10	2 649	110,4
140	14671B10	2 700	112,5
150	15671B10	2 767	115,3
160	16671B10	2 873	119,7
180	18671B10	2 990	124,6
200	20671B10	3 211	133,8
250	25671B10	3 483	145,1

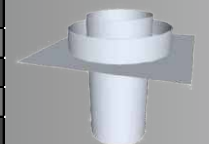

NEREZOVÝ SYSTÉM TROJZLOŽKOVÝ B10

Spodný dilatačný diel pre dymovod

⑥

DN	Kód produktu	Cena	€ - SK
130	13105SDB10	1 979	82,5
140	14105SDB10	2 053	85,5
150	15105SDB10	2 132	88,8
160	16105SDB10	2 224	92,7
180	18105SDB10	2 356	98,2
200	20105SDB10	2 583	107,6
250	25105SDB10	2 854	118,9



- s funkciou komína

Podporný diel

⑥

DN	Kód produktu	Cena	€ - SK
130	13854B10	2 900	120,8
140	14854B10	2 948	122,8
150	15854B10	3 012	125,5
160	16854B10	3 115	129,8
180	18854B10	3 226	134,4
200	20854B10	3 437	143,2
250	25854B10	3 578	149,1



Objímky k teleskopickým tyčiam STT

⑥

DN	Kód produktu	Cena	€ - SK
130	OTT190	358	14,9
150	OTT210	366	15,3
160	OTT220	401	16,7
180	OTT240	378	15,8
200	OTT260	385	16,0



Súprava 2 teleskopických tyčí

③

	Kód produktu	Cena	€ - SK
UNI	STT2800	2 249	93,7



- slúži na kotvenie nadstrešnej časti izolovaného komína
- je možné skracovať podľa potreby

DOSTUPNÉ FAREBNÉ VARIANTY

1 - Prírodný hliník

2 - RAL 9010 - Biela

3 - RAL 8011 - Svetlo hnedá

4 - RAL 8017 - Palisander

5 - RAL 3016 - Tehlová

6 - RAL 9005 - Čierna

7 - RAL 7016 - Komaxit

- doba dodania všetkých variantov je 2-3 týždne, upresní obchodný zástupca.

Popis systému:

Vnútorňá kovová stena - materiál 1.4404 1 mm

Tepelná izolácia - 90 kg/m³ - hrúbka 50 mm

Vonkajší plášť - Hliník AL99.5 podľa EN 673-3 - hrúbka 0,8 mm

Vzdialenosť od horľavých materiálov 100 mm

EN 1856-1 T200 P1 W V2 L50050 O(60) štandardné tesnenie

EN 1856-2 T250 P1 W V2 L50050 O(70) s tesnením XX003PL

<i>Peletky</i>		<i>strana</i>
A	Koleno 90°	63
B	Rúra 1000 mm	63
C	T - kus	63
D	Uzáver	63

Uľahčíte si prácu so zostavením a kalkuláciou
komínového systému:

www.ricomgas.sk

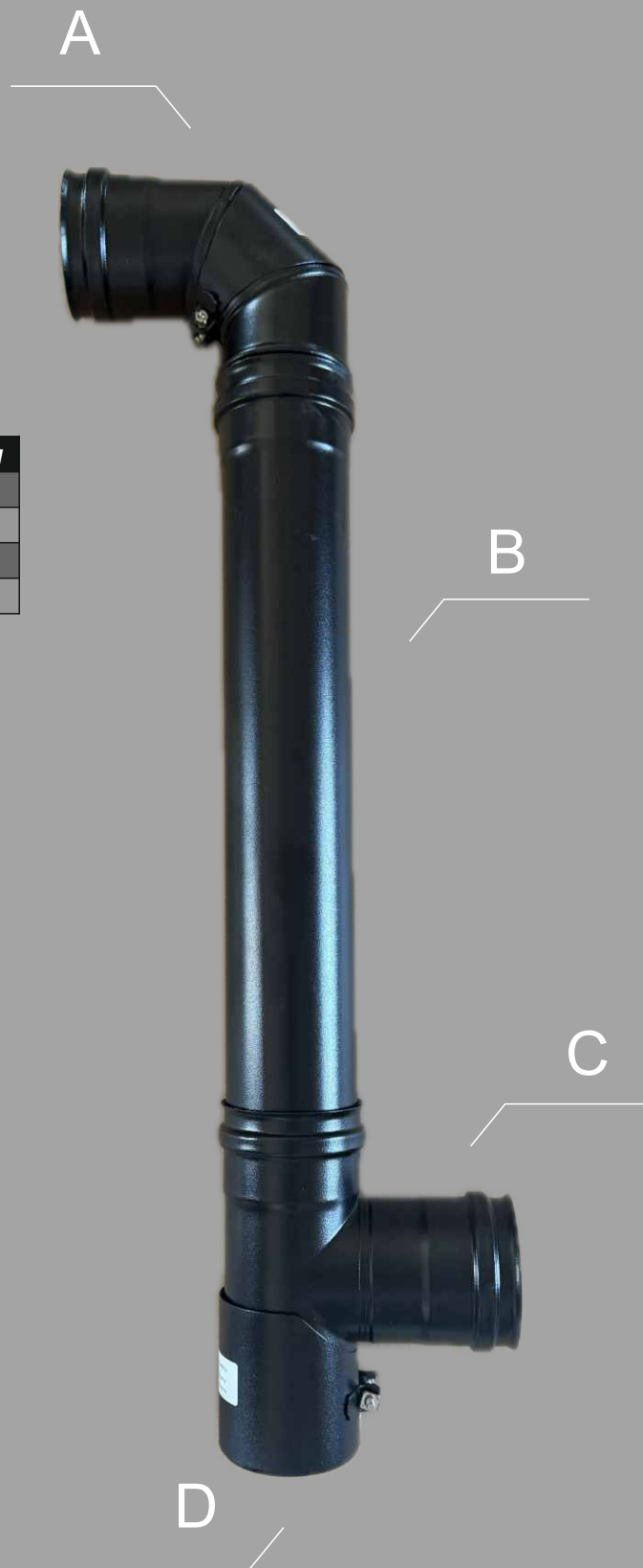

Rúra - 250 mm ③

DN	Kód produktu	Cena	€ - SK
80	08025PL	460	19,2
100	10025PL	567	23,6



Rúra - 500 mm ③

DN	Kód produktu	Cena	€ - SK
80	08024PL	562	23,4
100	10024PL	712	29,7



Rúra - 1000 mm ③

DN	Kód produktu	Cena	€ - SK
80	08020PL	893	37,2
100	10020PL	1 091	45,5



Rúra vsuvná ③

DN	Kód produktu	Cena	€ - SK
80	08023PL	524	21,8



Koleno 45° ③

DN	Kód produktu	Cena	€ - SK
80	08040PL	669	27,9
100	10040PL	681	28,4



Koleno 90° revízne segmentové ③

DN	Kód produktu	Cena	€ - SK
80	08432PL	1 814	75,6
100	10432PL	2 589	107,9



Koleno 90° segmentové ③

DN	Kód produktu	Cena	€ - SK
80	08433PL	706	29,4



Spojka ③

DN	Kód produktu	Cena	€ - SK
80	08100PL	583	24,3
100	10100PL	717	29,9



T-kus 90° ③

DN	Kód produktu	Cena	€ - SK
80	08F31PL	1 065	44,4
100	10F31PL	1 156	48,2



T-kus 90° inšpekčný ③

DN	Kód produktu	Cena	€ - SK
80	08F32PL	1 637	68,2



Uzáver ③

DN	Kód produktu	Cena	€ - SK
80	08060PL	508	21,2



Uzáver s odtokom ③

DN	Kód produktu	Cena	€ - SK
80	08061PL	583	24,3
100	10061PL	647	27,0



Objímka ③

DN	Kód produktu	Cena	€ - SK
80	08070PL	214	8,9
100	10070PL	225	9,4



Ružica 140 mm ③

DN	Kód produktu	Cena	€ - SK
80	0813BPL	177	7,4

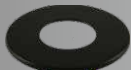

Ružica 180 mm ③

DN	Kód produktu	Cena	€ - SK
80	0813BPL/2	193	8,0
100	1013BPL/2	209	8,7

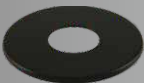

Manžeta silikón ③

DN	Kód produktu	Cena	€ - SK
80	08830PL	171	7,1
100	10830PL	193	8,0

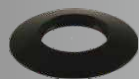

Tesnenie ③

DN	Kód produktu	Cena	€ - SK
80	08001PL	41	1,7



Tesnenie inšpekčné ③

DN	Kód produktu	Cena	€ - SK
80	08002PL	96	4,0



Tesnenie 250 °C ③

DN	Kód produktu	Cena	€ - SK
80	08003PL	102	4,3
100	10003PL	134	5,6



<i>Oceľové dymovody</i>		<i>strana</i>
A	rúra 500 mm	66
B	nastaviteľné 5 segm. koleno s čistiacim otvorom	67
C	rúra 1000 mm	66
D	žalúzie	68
E	koleno 90°	67
F	rúra 500 mm	66
G	koleno 90° s klapkou a čistiacim otvorom	67

Uľahčíte si prácu so zostavením a kalkuláciou komínového systému:

www.ricomgas.sk

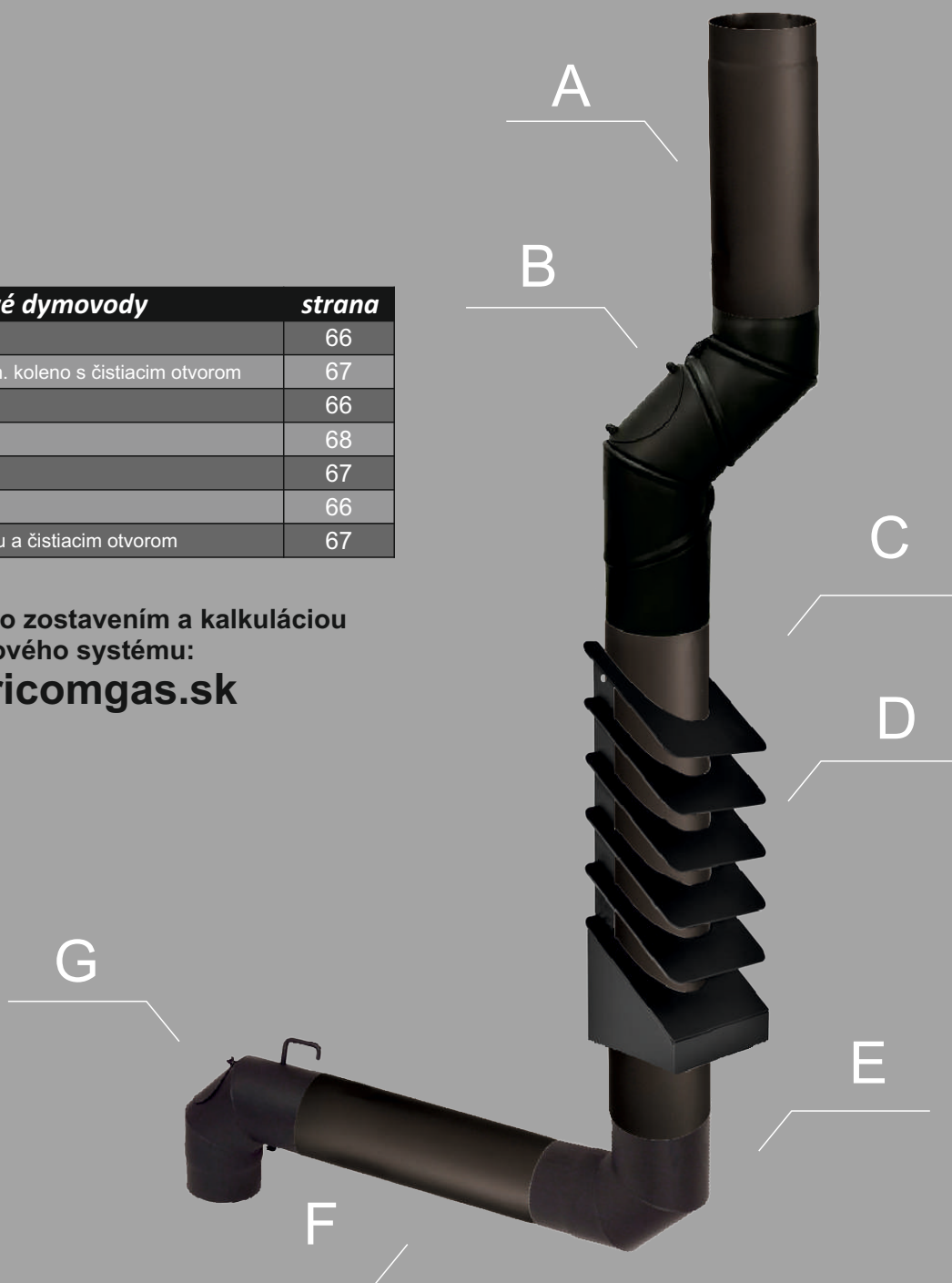

Rúra - 250 mm

②

DN	Kód produktu	Cena	€ - SK
120	1A025OC	286	11,9
125	12525OC	292	12,2
130	13025OC	297	12,4
145	14025OC	334	13,9
150	15025OC	340	14,2
160	16025OC	349	14,5
180	18025OC	377	15,7
200	20025OC	395	16,5



Rúra - 500 mm

②

DN	Kód produktu	Cena	€ - SK
120	1A024OC	449	18,7
125	12524OC	461	19,2
130	13024OC	471	19,6
145	14024OC	483	20,1
150	15024OC	496	20,7
160	16024OC	514	21,4
180	18024OC	582	24,3
200	20024OC	619	25,8



Rúra - 1000 mm

②

DN	Kód produktu	Cena	€ - SK
100	10020OC	624	26,0
120	1A020OC	687	28,6
125	12520OC	702	29,3
130	13020OC	732	30,5
145	14020OC	797	33,2
150	15020OC	823	34,3
160	16020OC	859	35,8
180	18020OC	995	41,5
200	20020OC	1 069	44,5



Rúra s klapkou - 250 mm

②

DN	Kód produktu	Cena	€ - SK
120	1A025OCKL	542	22,6
125	12525OCKL	548	22,8
130	13025OCKL	554	23,1
145	14025OCKL	591	24,6
150	15025OCKL	607	25,3
160	16025OCKL	616	25,7
180	18025OCKL	645	26,9
200	20025OCKL	647	27,0



Rúra s čistiacim otvorom - 1000 mm

②

DN	Kód produktu	Cena	€ - SK
120	1A020OCKO	846	35,3
130	13020OCKO	879	36,6
145	14020OCKO	947	39,5
150	15020OCKO	973	40,5
160	16020OCKO	1 011	42,1
180	18020OCKO	1 150	47,9
200	20020OCKO	1 239	51,6



Rúra s klapkou - 500 mm

②

DN	Kód produktu	Cena	€ - SK
120	1A024OCKL	696	29,0
125	12524OCKL	708	29,5
130	13024OCKL	719	30,0
145	14024OCKL	731	30,5
150	15024OCKL	753	31,4
160	16024OCKL	771	32,1
180	18024OCKL	841	35,0
200	20024OCKL	861	35,9



Rúra s klapkou - 1000 mm

②

DN	Kód produktu	Cena	€ - SK
120	1A020OCKL	953	39,7
130	13020OCKL	998	41,6
145	14020OCKL	1 064	44,3
150	15020OCKL	1 099	45,8
160	16020OCKL	1 135	47,3
180	18020OCKL	1 272	53,0
200	20020OCKL	1 330	55,4



Rúra s čistiacim otvorom - 250 mm

②

DN	Kód produktu	Cena	€ - SK
120	1A025OCKO	426	17,8
130	13025OCKO	430	17,9
145	14025OCKO	464	19,3
150	15025OCKO	472	19,7
160	16025OCKO	482	20,1
180	18025OCKO	514	21,4
200	20025OCKO	546	22,8



Rúra s čistiacim otvorom - 500 mm

②

DN	Kód produktu	Cena	€ - SK
120	1A024OCKO	579	24,1
125	12524OCKO	593	24,7
130	13024OCKO	598	24,9
140	14024OCKO	604	25,2
150	15024OCKO	618	25,8
160	16024OCKO	638	26,6
180	18024OCKO	709	29,5
200	20024OCKO	761	31,7



Rúra oceľová s odkvapom

②

DN	Kód produktu	Cena	€ - SK
120	1A255OCOKAP	387	16,1
130	13255OCOKAP	396	16,5
145	14255OCOKAP	436	18,2
150	15255OCOKAP	441	18,4
160	16255OCOKAP	446	18,6
180	18255OCOKAP	449	18,7
200	20255OCOKAP	453	18,9



- odkvap v rúre bez zúženia: použitie pre dymovod s funkciou komína, so zúženiami „po vode“

Všetky ceny sú uvedené bez DPH a dopravy

Koleno 45°

②

DN	Kód produktu	Cena	€ - SK
120	1A040OC	369	15,4
125	12540OC	377	15,7
130	13040OC	384	16,0
145	14040OC	421	17,5
150	15040OC	430	17,9
160	16040OC	442	18,4
180	18040OC	509	21,2
200	20040OC	528	22,0



Koleno 45° čistiace

②

DN	Kód produktu	Cena	€ - SK
120	1A040OCKO	528	22,0
130	13040OCKO	530	22,1
145	14040OCKO	532	22,2
150	15040OCKO	546	22,8
160	16040OCKO	612	25,5
180	18040OCKO	710	29,6



Koleno 90°

②

DN	Kód produktu	Cena	€ - SK
120	1A433OC	441	18,4
125	12433OC	450	18,8
130	13433OC	457	19,0
145	14433OC	476	19,8
150	15433OC	485	20,2
160	16433OC	499	20,8
180	18433OC	638	26,6
200	20433OC	666	27,8



Koleno 90° s klapkou

②

DN	Kód produktu	Cena	€ - SK
130	13433OCKL	713	29,7
145	14433OCKL	735	30,6
150	15433OCKL	754	31,4
160	16433OCKL	768	32,0



Koleno 90° čistiace s klapkou

②

DN	Kód produktu	Cena	€ - SK
130	13433OCKOKL	848	35,3
145	14433OCKOKL	873	36,4
150	15433OCKOKL	895	37,3
160	16433OCKOKL	910	37,9
180	18433OCKOKL	947	39,5



Koleno 90° čistiace

②

DN	Kód produktu	Cena	€ - SK
120	1A433OCKO	590	24,6
125	12533OCKO	592	24,7
130	13433OCKO	594	24,8
145	14433OCKO	612	25,5
150	15433OCKO	629	26,2
160	16433OCKO	645	26,9
180	18433OCKO	788	32,8
200	20433OCKO	808	33,7



Koleno segmentové otočné 0 - 90°

②

DN	Kód produktu	Cena	€ - SK
120	1A041OC	791	33,0
130	13041OC	794	33,1
145	14041OC	826	34,4
150	15041OC	826	34,4
160	16041OC	840	35,0
180	18041OC	1 010	42,1
200	20041OC	1 117	46,5



Koleno segmentové otočné 0 - 90°

②

s čistiacim otvorom

DN	Kód produktu	Cena	€ - SK
120	1A034OCKO	794	33,1
130	13034OCKO	817	34,0
150	15034OCKO	871	36,3
160	16034OCKO	891	37,1
180	18034OCKO	1 054	43,9



Koleno segmentové otočné 0 - 180°

②

s čistiacim otvorom

DN	Kód produktu	Cena	€ - SK
120	1A049OCKO	1 661	69,2
130	13049OCKO	1 638	68,3
150	15049OCKO	1 765	73,5
160	16049OCKO	1 862	77,6
180	18049OCKO	2 198	91,6
200	20049OCKO	2 381	99,2



Koleno segmentové otočné 0 - 45°

②

DN	Kód produktu	Cena	€ - SK
120	1A045OC	791	33,0
130	13045OC	771	32,1
145	14045OC	826	34,4
150	15045OC	826	34,4
160	16045OC	840	35,0
180	18045OC	1 010	42,1
200	20045OC	1 117	46,5



Žalúzie

(2)

DN	Kód produktu	Cena	€ - SK
130	ZALU13OC	1 502	62,6
150	ZALU15OC	1 502	62,6



T-kus ocelový

(2)

DN	Kód produktu	Cena	€ - SK
120	1A031OC	685	28,5
130	13031OC	715	29,8
150	15031OC	770	32,1
160	16031OC	793	33,0
180	18031OC	805	33,5
200	20031OC	820	34,2



Vsuvka 250 mm

(2)

DN	Kód produktu	Cena	€ - SK
120	VSU1A0OC	304	12,7
130	VSU130OC	313	13,0
145	VSU145OC	348	14,5
150	VSU150OC	353	14,7
160	VSU160OC	391	16,3
180	VSU180OC	419	17,5
200	VSU200OC	423	17,6



Adaptér

(2)

DN	Kód produktu	Cena	€ - SK
100/120	111012OC	305	12,7
110/120	111112OC	312	13,0
120/130	111213OC	319	13,3
120/150	111215OC	326	13,6
120/160	111216OC	333	13,9
125/130	1112513OC	340	14,2
125/150	1112515OC	347	14,5
130/150	111315OC	354	14,8
140/150	111415OC	361	15,0
145/150	1114515OC	368	15,3
180/180	1114516OC	375	15,6
150/160	111516OC	382	15,9
150/180	111518OC	389	16,2
150/200	111520OC	396	16,5
160/180	111618OC	403	16,8



Zder

(2)

DN	Kód produktu	Cena	€ - SK
120	1A062OC	158	6,6
125	12562OC	160	6,7
130	13062OC	163	6,8
145	14062OC	168	7,0
150	15062OC	171	7,1
160	16062OC	174	7,3
180	18062OC	183	7,6
200	20062OC	191	8,0



Adaptér vkladací

(2)

DN	Kód produktu	Cena	€ - SK
100/120	101210OC	446	18,6
110/120	101211OC	457	19,0
120/130	101312OC	468	19,5
120/145	101412OC	479	20,0
120/150	101512OC	490	20,4
120/155	1015512OC	501	20,9
120/160	101612OC	512	21,3
120/175	1017512OC	523	21,8
120/180	101812OC	534	22,3
120/195	1019512OC	545	22,7
120/200	102012OC	556	23,2
125/130	1013125OC	478	19,9
125/150	1015125OC	501	20,9
125/160	1016125OC	522	21,8
125/180	1018125OC	544	22,7
130/140	101413OC	489	20,4
130/150	101513OC	512	21,3
130/160	101613OC	523	21,8
130/180	101813OC	554	23,1
130/195	1019513OC	565	23,5
130/200	102013OC	576	24,0
130/250	102513OC	587	24,5
140/150	101514OC	522	21,8
145/150	1015145OC	522	21,8
145/160	1016145OC	533	22,2
145/180	1018145OC	564	23,5
140/200	102014OC	586	24,4
150/160	101615OC	543	22,6
150/170	101715OC	554	23,1
150/175	1017515OC	575	24,0
150/180	101815OC	586	24,4
150/195	1019515OC	597	24,9
150/200	102015OC	608	25,3
160/180	101816OC	596	24,8
160/195	1019516OC	618	25,8
160/200	102016OC	629	26,2
180/200	102018OC	606	25,3
200/250	102520OC	639	26,6

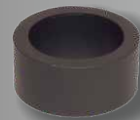

- vonkajší priemer je kompatibilný s odbočkou T-kusu S8V2 a S10

Adaptér pre keramický komín ②

DN	Kód produktu	Cena	€ - SK
140/140	141414OC	703	29,3
120/150	141512OC	703	29,3
130/150	141513OC	703	29,3
150/150	141515OC	703	29,3
125/160	1416125OC	703	29,3
120/160	141612OC	703	29,3
130/160	141613OC	703	29,3
145/160	1416145OC	703	29,3
140/160	141614OC	703	29,3
150/160	141615OC	715	29,8
160/160	141616OC	715	29,8
125/180	1418125OC	715	29,8
120/180	141812OC	768	32,0
130/180	141813OC	768	32,0
145/180	1418145OC	768	32,0
140/180	141814OC	768	32,0
150/180	141815OC	768	32,0
160/180	141816OC	768	32,0
180/180	141818OC	768	32,0
125/200	1420125OC	807	33,6
120/200	142012OC	807	33,6
130/200	142013OC	807	33,6
140/200	142014OC	807	33,6
150/200	142015OC	807	33,6
160/200	142016OC	807	33,6
180/200	142018OC	807	33,6
200/200	142020OC	807	33,6



Adaptér pre keramický komín prevlečený ②

DN	Kód produktu	Cena	€ - SK
130/150	151513OC	905	37,7
125/160	1516125OC	905	37,7
120/160	151612OC	905	37,7
130/160	151613OC	905	37,7
140/160	151614OC	905	37,7
150/160	151615OC	905	37,7
160/160	151616OC	905	37,7
120/180	151812OC	937	39,0
130/180	151813OC	937	39,0
140/180	151814OC	937	39,0
150/180	151815OC	937	39,0
160/180	151816OC	937	39,0
180/180	151818OC	937	39,0
120/200	152012OC	993	41,4
130/200	152013OC	993	41,4
140/200	152014OC	993	41,4
150/200	152015OC	993	41,4
160/200	152016OC	993	41,4
180/200	152018OC	993	41,4
200/200	152020OC	993	41,4



Prechodka oceľ / nerez ②

DN	Kód produktu	Cena	€ - SK
120	1112SWOC	246	10,3
130	1113SWOC	250	10,4
150	1115SWOC	256	10,7
160	1116SWOC	259	10,8
180	1118SWOC	265	11,0
200	1120SWOC	272	11,3



Adaptér pre hrubostennú keramiku ②

DN	Kód produktu	Cena	€ - SK
150/160	151615OC-S	961	40,0
160/160	151616OC-S	961	40,0
120/180	151812OC-S	1 005	41,9
160/180	151816OC-S	990	41,3
180/180	151818OC-S	990	41,3
150/200	152015OC-S	1 030	42,9



Adaptér pre keramický komín 45° vkladací, oceľový ②

DN	Kód produktu	Cena	€ - SK
150/180	14181545OC	1320	55,0
150/200	14201545OC	1 458	60,8
160/200	14201645OC	1 475	61,5
180/200	14201845OC	1 483	61,8
200/200	14202045OC	1 491	62,1

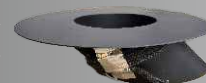

- Iba pre zrezaný T-kus

Izolačný výsek do kontrolných otvorov ②

oceľových komponentov

DN	Kód produktu	Cena	€ - SK
120-145	IZOLKO-120-145	40	1,7
150-200	IZOLKO-150-200	40	1,7



Ružica 0,5 mm

②

DN	Kód produktu	Cena	€ - SK
120	1A013OC	98	4,1
125	12513OC	99	4,1
130	13013OC	101	4,2
145	14013OC	102	4,3
150	15013OC	102	4,3
160	16013OC	103	4,3
180	18013OC	103	4,3
200	20013OC	103	4,3



- kompatibilná so zúžením

Ružica 0,5 mm

②

DN	Kód produktu	Cena	€ - SK
120	1A013OC/2	100	4,2
130	13013OC/2	101	4,2
145	14013OC/2	101	4,2
150	15013OC/2	101	4,2
160	16013OC/2	101	4,2
180	18013OC/2	103	4,3
200	20013OC/2	103	4,3



- kompatibilná s rúrou

Komínové viečko

②

DN	Kód produktu	Cena	€ - SK
120	1A063OC	281	11,7
125	12563OC	285	11,9
130	13063OC	289	12,0
145	14063OC	297	12,4
150	15063OC	314	13,1
160	16063OC	335	14,0
180	18063OC	351	14,6
200	20063OC	368	15,3

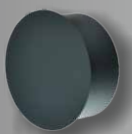

Charakteristika podľa EN 1856-2

Pretlakové flexibilné rúry *EN 1856-2* *T200* *P1* *W* *V2* *L50010* *0*

Podtlakové flexibilné rúry *EN 1856-2* *T400* *N1* *D* *Vm* *L50040* *0*

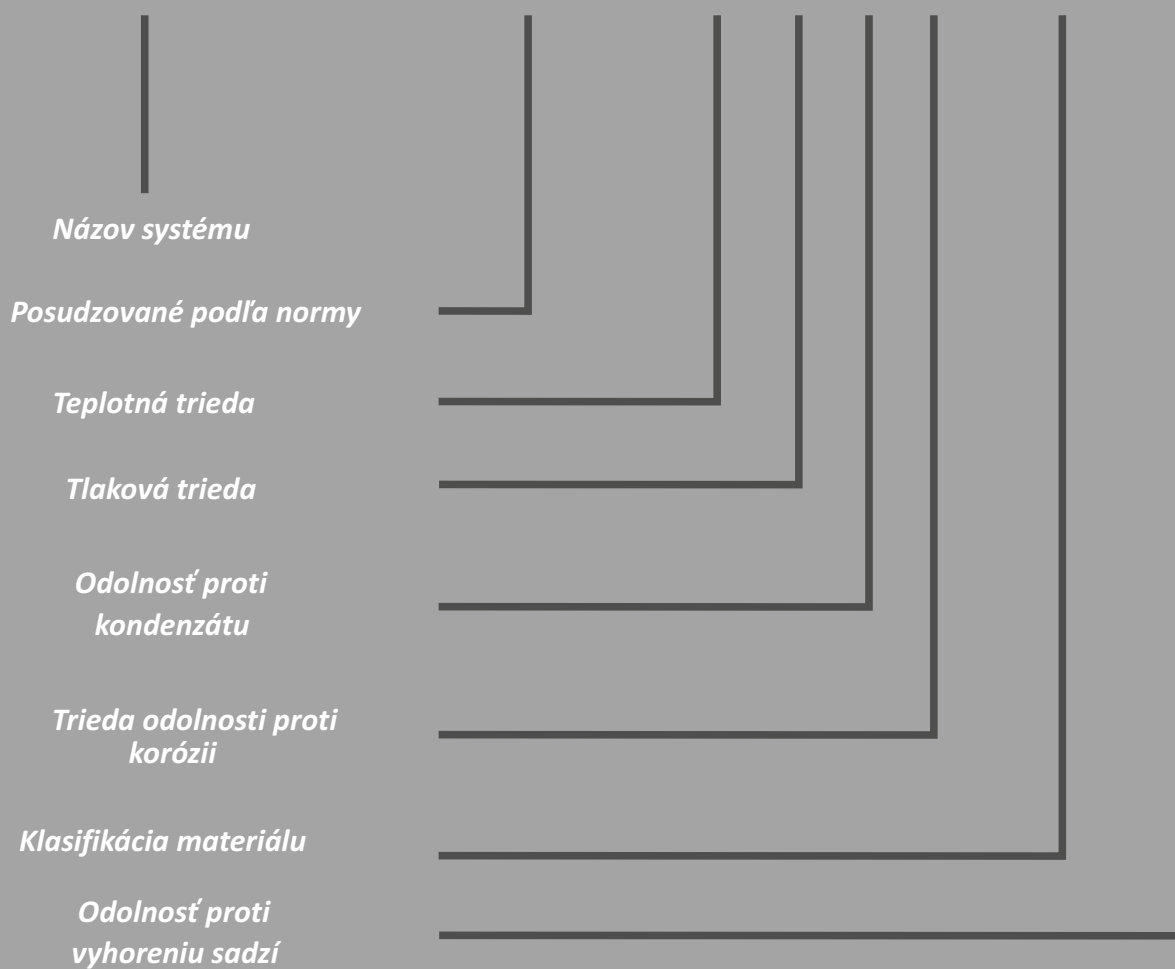

Mokrú aj suchú prevádzku

Podtlakovú aj pretlakovú prevádzku

	<i>Flexibilný nerezový systém</i>	<i>strana</i>
A	komínová hlavica	13
B	prechodka F/P vrchná	74
C	flexibilná rúra	73
D	prechodka P/F spodná	74
E	t - kus 90°	11
F	uzáver	11

Uľahčíte si prácu so zostavením a kalkuláciou komínového systému:

www.ricomgas.sk

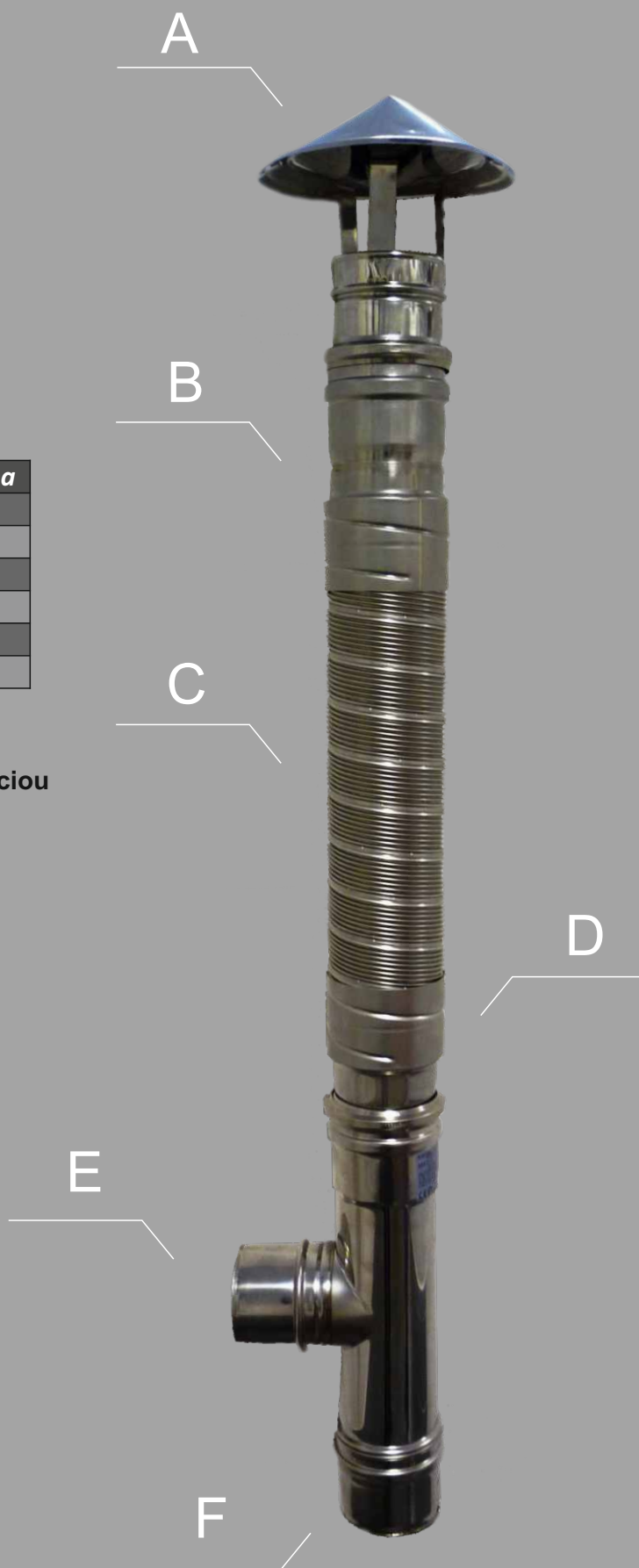

FLEXIBILNÝ NEREZOVÝ SYSTÉM - PRETLAK

Flexibilná rúra jednovrstvová - pretlaková

⑦

materiál nerez - 0,10 mm

DN	Kód	Cena	€ - SK
60	10.0110060	214	8,9
80	10.0110080	284	11,8
100	10.0110100	354	14,8
110	10.0110110	390	16,3
120	10.0110120	426	17,8
125	10.0110125	443	18,5
130	10.0110130	461	19,2
140	10.0110140	497	20,7
150	10.0110150	532	22,2
160	10.0110160	567	23,6
180	10.0110180	638	26,6
200	10.0110200	710	29,6
250	10.0110250	886	36,9
300	10.0110300	1 064	44,3



EN 1856-2 T200 P1 W V2 L50010 O
EN 1856-2 T400 N1 D V2 L50010 G

Flexibilná rúra jednovrstvová - pretlaková

⑦

materiál nerez - 0,12 mm

DN	Kód	Cena	€ - SK
60	10.0112060	252	10,5
80	10.0112080	335	14,0
100	10.0112100	419	17,5
110	10.0112110	461	19,2
120	10.0112120	502	20,9
125	10.0112125	523	21,8
130	10.0112130	544	22,7
140	10.0112140	586	24,4
150	10.0112150	628	26,2
160	10.0112160	670	27,9
180	10.0112180	754	31,4
200	10.0112200	837	34,9
250	10.0112250	1 047	43,6
300	10.0112300	1 257	52,4



EN 1856-2 T200 P1 W V2 L50012 O
EN 1856-2 T400 N1 D V2 L50012 G

Flexibilná rúra dvojvrstvová - pretlaková

⑦

materiál nerez - 2 x 0,10 mm

DN	Kód	Cena	€ - SK
80	10.0210080	469	19,5
100	10.0210100	585	24,4
110	10.0210110	644	26,8
120	10.0210120	703	29,3
125	10.0210125	732	30,5
130	10.0210130	761	31,7
140	10.0210140	820	34,2
150	10.0210150	879	36,6
160	10.0210160	937	39,0
180	10.0210180	1 054	43,9
200	10.0210200	1 171	48,8
250	10.0210250	1 464	61,0
300	10.0210300	1 757	73,2
400	10.0210400	2 342	97,6



- kompatibilná s prechodkami s označením /2

EN 1856-2 T200 P1 W V2 L50 2x010 O
EN 1856-2 T400 N1 D V2 L50 2x010 G

Flexibilná rúra dvojvrstvová - pretlaková

⑦

materiál nerez - 2 x 0,12 mm

DN	Kód	Cena	€ - SK
80	10.0212080	540	22,5
100	10.0212100	675	28,1
110	10.0212110	743	31,0
120	10.0212120	810	33,8
125	10.0212125	807	33,6
130	10.0212130	878	36,6
140	10.0212140	946	39,4
150	10.0212150	1 013	42,2
160	10.0212160	1 080	45,0
180	10.0212180	1 215	50,6
200	10.0212200	1 351	56,3
250	10.0212250	1 688	70,3



- kompatibilná s prechodkami s označením /2

EN 1856-2 T200 P1 W V2 L50 2x012 O
EN 1856-2 T400 N1 D V2 L50 2x012 G

Flexibilná rúra dvojvrstvomá - vo vnútri hladká ⑦

materiál nerez - 2 x 0,10 mm

DN	Kód	Cena	€ - SK/m
80	9.0210080	526	21,9
100	9.0210100	658	27,4
110	9.0210110	724	30,2
120	9.0210120	790	32,9
125	9.0210125	822	34,3
130	9.0210130	855	35,6
140	9.0210140	921	38,4
150	9.0210150	987	41,1
160	9.0210160	987	41,1
180	9.0210180	1184	49,3
200	9.0210200	1 317	54,9
250	9.0210250	1 644	68,5
300	9.0210300	1 973	82,2
350	9.0210350	2 302	95,9
400	9.0210400	3 156	131,5



EN 1856-2 T200 P1 W V2 L50 2x010 O

EN 1856-2 T400 N1 D V2 L50 2x010 G

Flexibilná rúra dvojvrstvomá - vo vnútri hladká ⑦

materiál nerez - 2 x 0,12 mm

DN	Kód	Cena	€ - SK/m
80	9.0212080	632	26,3
100	9.0212100	789	32,9
110	9.0212110	861	35,9
120	9.0212120	947	39,5
125	9.0212125	987	41,1
130	9.0212130	1026	42,8
140	9.0212140	1104	46,0
150	9.0212150	1183	49,3
160	9.0212160	1262	52,6
180	9.0212180	1 420	59,2
200	9.0212200	1 578	65,8
250	9.0212250	1 972	82,2
300	9.0212300	2 366	98,6
400	9.0212400	2 367	98,6



EN 1856-2 T200 P1 W V2 L50 2x012 O

EN 1856-2 T400 N1 D V2 L50 2x012 G

Prechodka F/P - vrchná ③

DN	Kód produktu	Cena	€ - SK
60	Z21400020060	769	32,0
80	Z21400020080	869	36,2
100	Z21400020100	881	36,7
110	21400020110	645	26,9
120	21400020120	665	27,7
125	21400020125	685	28,5
130	21400020130	705	29,4
140	21400020140	725	30,2
150	21400020150	745	31,0
160	21400020160	765	31,9
180	21400020180	785	32,7
200	21400020200	815	34,0
250	21400020250	855	35,6
300	21400020300	995	41,5
350	21400020350	1 285	53,5



- so závitom

Prechodka P/F - spodná ③

DN	Kód produktu	Cena	€ - SK
60	Z21400000060	608	25,3
80	Z21400000080	434	18,1
100	Z21400000100	465	19,4
110	21400000110	495	20,6
120	21400000120	515	21,5
125	21400000125	535	22,3
130	21400000130	555	23,1
140	21400000140	575	24,0
150	21400000150	595	24,8
160	21400000160	615	25,6
180	21400000180	635	26,5
200	21400000200	665	27,7
250	21400000250	705	29,4
300	21400000300	945	39,4
350	21400000350	1 135	47,3



- so závitom

Prechodka F/F - spojka ③

DN	Kód produktu	Cena	€ - SK
60	Z21400010060	753	31,4
80	Z21400010080	686	28,6
100	Z21400010100	755	31,5
110	21400010110	495	20,6
120	21400010120	515	21,5
125	21400010125	535	22,3
130	21400010130	555	23,1
140	21400010140	575	24,0
150	21400010150	595	24,8
160	21400010160	615	25,6
180	21400010180	635	26,5
200	21400010200	665	27,7
250	21400010250	705	29,4
300	21400010300	945	39,4
350	21400010350	1 135	47,3



- so závitom

Prechodka spodná P/F k hadiciam 10.02XXXX

③

DN	Kód	Cena	€ - SK
80*	Z21400000080/2	434	18,1
100*	Z21400000100/2	481	20,0



* - s jemným závitom

Spojka F/F k hadiciam 10.02XXXX

③

DN	Kód	Cena	€ - SK
80*	Z21400010080/2	686	28,6
100*	Z21400010100/2	755	31,5



* - s jemným závitom

Prechodka horná F/P k hadiciam 10.02XXXX

③

DN	Kód	Cena	€ - SK
80*	Z21400020080/2	869	36,2
100*	Z21400020100/2	881	36,7



* - s jemným závitom

Spojovacia objímka k pretlakovým flex hadiciam

⑥

DN	Kód	Cena	€ - SK
110	11070FLEX	129	5,4
120	12070FLEX	129	5,4
125	12570FLEX	129	5,4
130	13070FLEX	129	5,4
140	14070FLEX	129	5,4
150	15070FLEX	129	5,4
160	16070FLEX	129	5,4
180	18070FLEX	129	5,4
200	20070FLEX	129	5,4



Ukončenie pre prisávanie

⑥

DN	Kód	Rozměr	Cena	€ - SK
80	13011SP30	30x30	2 042	85,1
80	13011SP40	40x40	1 945	81,0



Krycí plech lisovaný

⑦

DN	Kód	Cena	€ - SK
80	24000003080	1 017	42,4
100	24000003100	1 017	42,4

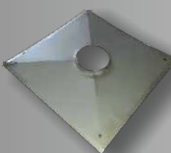

Matica so závitom ku krycímu plechu

⑦

DN	Kód	Cena	€ - SK
80	21410000080	196	8,2
100	21410000100	215	9,0



- matica pre zavesenie nerezovej flexibilnej vložky pri použití s krycím plechom

AK matica so závitom pre kotvenie flexi rúry

⑦

DN	Kód	Cena	€ - SK
60	21410000060	307	12,8



- kompatibilný so všetkými ukončovacími krytmi komína v DN 80

Montážna hlava

⑦

DN	Kód	Cena	€ - SK
60	21420000060	775	32,3
80*	21420000080	771	32,1
100*	21420000100	535	22,3
110	21420000110	555	23,1
120	21420000120	555	23,1
125	21420000125	568	23,7
130	21420000130	572	23,8
140	21420000140	578	24,1
150	21420000150	582	24,3
160	21420000160	586	24,4
170	21420000170	599	25,0
180	21420000180	599	25,0
200	21420000200	615	25,6



* - so závitom

- montážne hlavy pre inštaláciu nerezových flexibilných vložiek
- závit zodpovedá jednovrstvovej nerezovej flexibilnej rúry
- pri všetkých priemeroch pri inštalácii použite silikón - SIGMotor

AK Spona

③

DN	Kód	Rozmer	Cena	€ - SK
80	21050000080	159 mm	383	16,0
100-110	21050000110	148 mm	415	17,3
120	21050000120	151 mm	415	17,3
130	21050000130	148 mm	415	19,8
140	21050000140	148 mm	475	19,8
150	21050000150	127 mm	475	19,8
160	21050000160	116 mm	475	19,8
180	21050000180	159 mm	488	20,3
200	21050000200	135 mm	563	23,5
250	21050000250	189 mm	606	25,3
300	21050000300	190 mm	844	35,2



- spona na uchytenie komínovej vložky na komín
* - DN 100 - 110

AL Spona

③

DN	Kód	Cena	€ - SK
60	22050000060	214	8,9
75	22050000075	214	8,9
100+110	22050000110	214	8,9
120+130	22050000120	214	8,9
150	22050000150	234	9,8
160	22050000160	248	10,3

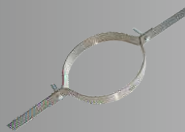

Golier nízky

③

DN	Kód produktu	Cena	€ - SK
60	06013SW	568	23,7
80	08013SW	473	19,7
100	10013SW	630	26,3
110	11013SW	663	27,6
120	1A013SW	701	29,2
130	13013SW	764	31,8
140	14013SW	777	32,4
150	15013SW	795	33,1
160	16013SW	799	33,3
180	18013SW	802	33,4
200	20013SW	883	36,8
250	25013SW	1 120	46,7
300	30013SW	1 260	52,5



SigMotor

③

Kód produktu	Cena	€ - SK
SigMotor	164	6,8



Skrátené koleno šróbovacie

③

plast s prechodom na flex nerez

DN	Kód	Cena	€ - SK
60	2141006080PBS280	1 535	64,0
80	21410080BS280	1 350	56,3
80	21410080BS280/2	1 350	56,3
80	21410080BS80	1 108	46,2
80	21410080BS80/2	1 209	50,4
80	21410080PBS280	1 470	61,3
80	21410080PBS280/2	1 470	61,3
80	21410080PBS80	1 228	51,2
80	21410080PBS80/2	1 329	55,4



Vystredovacia dištančná objímka dvojité

⑮

DN	Kód produktu	Cena	€ - SK
80	37080/2	291	12,1
100	37100/2	310	12,9
110	37110/2	334	13,9
125	37125/2	370	15,4
130	37130/2	424	17,7
140	37140/2	443	18,5
150	37150/2	455	19,0
160	37160/2	475	19,8
180	37180/2	497	20,7
200	37200/2	545	22,7
250	37250/2	557	23,2
300	37300/2	709	29,5



Konzola zakladacia pre T- kus

⑮

DN	Kód produktu	Cena	€ - SK
80	48080	714	29,8
110	48110	884	36,8
125	48125	1 060	44,2
130	48130	830	34,6
140	48140	878	36,6
150	48150	920	38,3
160	48160	1 223	51,0
180	48180	1 108	46,2
200	48200	1 259	52,5
250	48250	1 278	53,3
300	48300	2 064	86,0

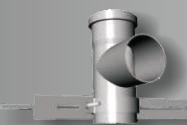
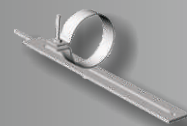

ukážka použitia

*- DN 80 -100

<i>Flexibilný nerezový systém</i>		<i>strana</i>
A	unihlavica	45
B	flexibilná rúra	78
C	t - kus 90°	42
D	čistiaci kus s dvierkami	44
E	uzáver s bočným odtokom	44

Uľahčíte si prácu so zostavením a kalkuláciou komínového systému:

www.ricomgas.sk

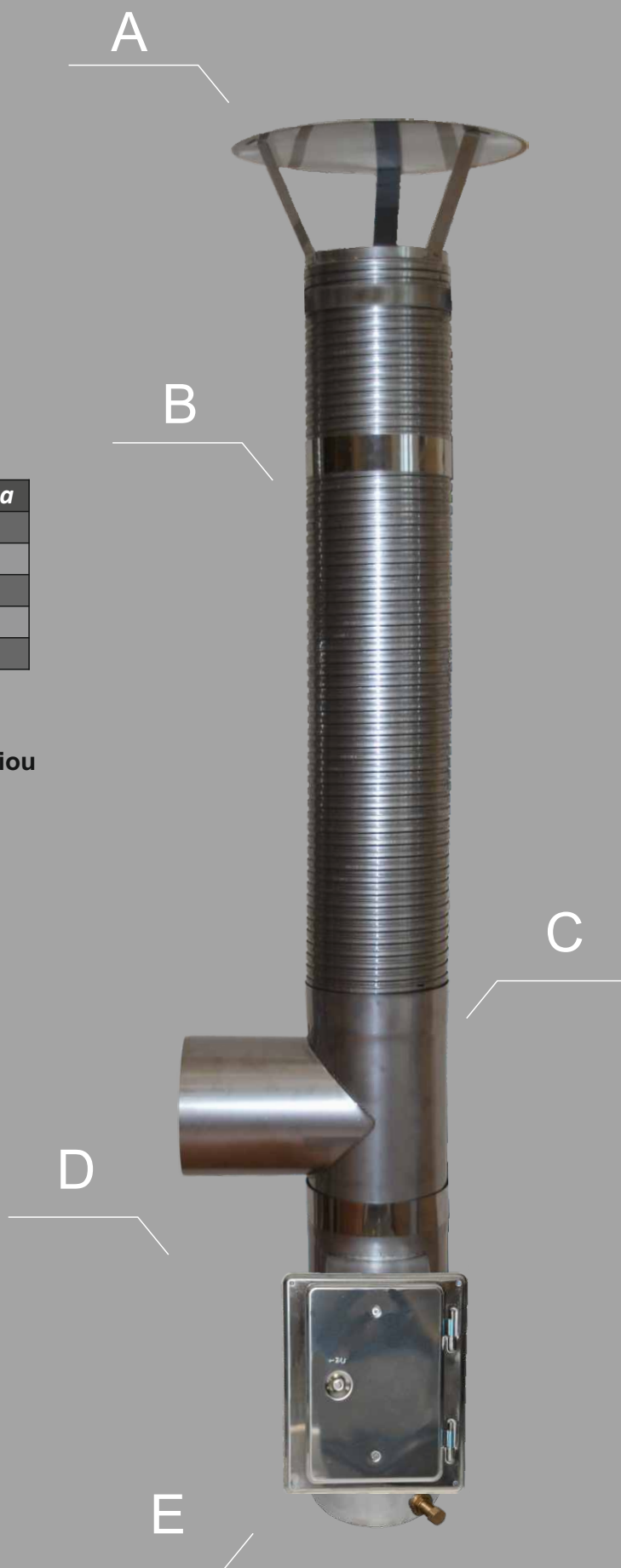

Flexibilná rúra jednovrstvová - podtlaková 
materiál 1.4404 - 0,40 mm - (pevné palivá)

DN	Kód	Cena	€ - SK
130	14.0140130	1 066	44,4
140	14.0140140	1 114	46,4
150	14.0140150	1 172	48,8
160	14.0140160	1 268	52,8
180	14.0140180	1 416	59,0
200	14.0140200	1 565	65,2



EN 1856-2 T400 N1 D Vm L50 040 O

Inštalujte podľa šípky smeru toku spalín - vyrazené na výrobku



ricom
gas

Flexi. hadica pre sanáciu kom. telies, hr. 0,08 mm ⁷

DN	Kód	Cena	€ - SK
80	10.0108080	283	11,8
100	10.0108100	333	13,9
110	10.0108110	367	15,3
120	10.0108120	373	15,5
125	10.0108125	416	17,3
130	10.0108130	433	18,0
140	10.0108140	467	19,5
150	10.0108150	500	20,8
160	10.0108160	500	20,8
180	10.0108180	600	25,0
200	10.0108200	667	27,8
250	10.0108250	834	34,8
300	10.0108300	1 000	41,7



- nemožno použiť na odťah spalín

Hliníková flexi hadica, hr. 0,35 mm ¹

DN	Kód	Cena	€ - SK
125	15.0135125	251	10,5



- nemožno použiť na odťah spalín



ricom gas

Hliníková ohybná hadica - hr. 0,10 mm

①

DN	Kód	Cena	€ - SK
80	8.0110080	42	1,8
100	8.0110100	52	2,2
110	8.0110110	59	2,5
120	8.0110120	63	2,6
125	8.0110125	68	2,8
130	8.0110130	69	2,9
140	8.0110140	73	3,0
150	8.0110150	79	3,3
160	8.0110160	84	3,5
180	8.0110180	94	3,9
200	8.0110200	105	4,4
250	8.0110250	130	5,4
300	8.0110300	157	6,5
400	8.0110400	208	8,7



Hliníkový T- kus 90° - hr. 0,63 mm

①

DN	Kód	Cena	€ - SK
80	08031AL	708	29,5
100	10031AL	708	29,5
110	11031AL	721	30,0
120	12031AL	721	30,0
130	13031AL	740	30,8
140	14031AL	740	30,8
150	15031AL	740	30,8
160	16031AL	799	33,3
180	18031AL	849	35,4
200	20031AL	849	35,4
250	25031AL	1 196	49,8
300	30031AL	1 196	49,8
350	35031AL	1 795	74,8
400	40031AL	1 795	74,8



Hliníková rúra - 1000 mm, hr. - 0,63 mm

①

DN	Kód	Cena	€ - SK
80	08020AL	371	15,5
100	10020AL	371	15,5
110	11020AL	405	16,9
120	12020AL	405	16,9
130	13020AL	456	19,0
140	14020AL	455	19,0
150	15020AL	455	19,0
160	16020AL	576	24,0
180	18020AL	576	24,0
200	20020AL	576	24,0
250	25020AL	903	37,6
300	30020AL	903	37,6
350	35020AL	1 601	66,7
400	40020AL	1 601	66,7



Hliníkové koleno 45° - hr. 0,63 mm

①

DN	Kód	Cena	€ - SK
80	08040AL	359	15,0
100	10040AL	359	15,0
110	11040AL	366	15,3
120	12040AL	366	15,3
130	13040AL	386	16,1
140	14040AL	386	16,1
150	15040AL	386	16,1
160	16040AL	414	17,3
180	18040AL	414	17,3
200	20040AL	414	17,3
250	25040AL	503	21,0
300	30040AL	503	21,0
350	35040AL	600	25,0
400	40040AL	701	29,2



Hliníkové koleno revízne 90° - hr. 0,63 mm

①

DN	Kód	Cena	€ - SK
80	08432AL	946	39,4
100	10432AL	946	39,4
110	11432AL	946	39,4
120	12432AL	946	39,4
130	13432AL	974	40,6
140	14432AL	974	40,6
150	15432AL	974	40,6
160	16432AL	1 012	42,2
180	18432AL	1 012	42,2
200	20432AL	1 012	42,2



Hliníkové koleno 90° - hr. 0,63 mm

①

DN	Kód	Cena	€ - SK
80	08433AL	678	28,3
100	10433AL	678	28,3
110	11433AL	678	28,3
120	12433AL	678	28,3
130	13433AL	721	30,0
140	14433AL	721	30,0
150	15433AL	721	30,0
160	16433AL	759	31,6
180	18433AL	759	31,6
200	20433AL	759	31,6
250	25433AL	895	37,3
300	30433AL	895	37,3
350	35433AL	1 196	49,8
400	40433AL	1 795	74,8





RICOM gas s.r.o.
Devínska Nová Ves 7468
841 07 Bratislava



www.ricomgas.sk